



# K. S INSTITUTE OF TECHNOLOGY, BENGALURU-560109

14, Kanakapura Main Road, Raghuvanahalli, Bengaluru, Karnataka - 560109

## \*\* DEPARTMENT OF TRAINING AND PLACEMENTS \*\*

Date: 25/07/2023

### SOFT SKILLS TRAINING FOR 2<sup>nd</sup> SEMESTER STUDENTS – 2026 BATCH

Placement Department has planned to conduct Personality Development Training Program for 2<sup>nd</sup> Semester students starting from 03/08/2023 to 08/08/2023 from 8.50 AM to 03.50 PM. All HOD's are hereby requested to communicate their first-year students regarding the same.

The training will be conducted in Class rooms, NB. Batch wise details are shared below. All placement coordinators are requested to submit the consolidated **attendance of all 5 days** to Placement Department and to take the **feedback** for all the days. Department wise schedule is given below for your reference.

Date	Time	Batch 1	Batch 2	Batch 3	Batch 4	Batch 5	Batch6	Batch7	Batch 8	Batch 9
		CSE-A	CSE-B	CSE-C	ECE-A	ECE-B	AIML	CSD	IOT	CCE+MECH
3 <sup>rd</sup> , 4 <sup>th</sup> , 5 <sup>th</sup> , 7 <sup>th</sup> and 8 <sup>th</sup> AUGUST 2023	8.50 AM - 11.00 AM	NB-101	NB-102	NB-104	NB-205	NB-301	NB-203	NB-202	NB-302	NB-304
	11.00 AM - 11.15 AM	Break								
	11.15AM - 1.15 PM	NB-101	NB-102	NB-104	NB-205	NB-301	NB-203	NB-202	NB-302	NB-304
	1.15 PM - 1.50 PM	Lunch Break								
	1.50 PM - 3.50 PM	NB-101	NB-102	NB-104	NB-205	NB-301	NB-203	NB-202	NB-302	NB-304

#### NOTE:

- All the students are informed to attend the session compulsorily in **Placement Dress code ONLY** (Solid White Shirt and Black trousers).
- Students are strictly informed to be present in their allocated rooms only for all the five days. **DO NOT SWAP THE BATCHES.**
- Feedback QR code will be displayed in all the training rooms. Students are informed to provide the feedback for each session before leaving the class.
- Certificates will be provided to those students having 100% attendance



CC to HOD's and Coordinators of:

BS

*Dr. Karishma*

*Dr. Karishma*  
PRINCIPAL  
PRINCIPAL  
K.S. INSTITUTE OF TECHNOLOGY  
BENGALURU - 560 109.



**\*\*DEPARTMENT OF TRAINING AND PLACEMENTS\*\***

Date: 26/07/23

**SOFT SKILLS TRAINING FOR 2<sup>ND</sup> AND 4<sup>TH</sup> SEMESTER STUDENTS**

Dear all,

This is to inform you that Placement Department is conducting soft skills training for the 2<sup>nd</sup> and 4<sup>th</sup> semester students of KSIT, the students are required to attend the training sessions without fail.

If anybody is absent for any of the sessions, he/she is liable to pay a fine equivalent to the training cost.



*Sharma. C*  
PRINCIPAL  
PRINCIPAL  
K.S. INSTITUTE OF TECHNOLOGY  
BENGALURU - 560 109.

CC TO:

HODs and Coordinators of:

AIML <i>[Signature]</i>	CSE <i>[Signature]</i>	CSD <i>[Signature]</i>	ECE <i>[Signature]</i>	MECH <i>[Signature]</i>	AS & H <i>[Signature]</i>
----------------------------	---------------------------	---------------------------	---------------------------	----------------------------	------------------------------





# K. S INSTITUTE OF TECHNOLOGY, BENGALURU-560109

14, Kanakapura Main Road, Raghuvanahalli, Bengaluru, Karnataka - 560109

## 4<sup>TH</sup> SEM CLASS TEACHERS

SL NO	BRANCH&SECTION	CLASS TEACHERS NAME	DATE	SIGNATURE
1	CSE-A	Abhilash L Bhat	26/07/23	Abhilash
2	CSE-B	Namyapriya D	27/07/23	Namyapriya
3	ECE-A	Bhanumathi A	26/7/23	Bhanumathi
4	ECE-B	Anita P	26/7/23	Anita
5	AIML	LAKSHMI K K	26/7/23	Lakshmi
6	CSD	SUSHMA A	26/7/23	Sushma
7	MECH	HARISH U	27/7/23	Harish

## 2<sup>ND</sup> SEM CLASS TEACHERS

SL NO	BRANCH & SECTION	CLASS TEACHER NAME	DATE	SIGNATURE
1	CSE-A	Radhika N.P	26/7/23	Radhika
2	CSE-B	Mamatha N	26/7/23	Mamatha
3	CSE-C	SHYLATA KR	26/07/23	Shylata
4	CSD-D	Dr. Harisha S	27/07/23	Harisha
5	AMIL-E	Lekshmi C	26/7/23	Lekshmi
6	ECE-F	Kanya T N	26/7/23	Kanya
7	ECE-G	Dr Renuka C	26/7/23	Renuka
8	IOT-H	Dr. Madhavi S	26/07/2023	Madhavi
9	CCE-I	Sneha G Kulkarni	26/07/2023	Sneha
10	MECH-J	TEJASWINI R	26.07.23	Tejaswini



K S GROUP OF INSTITUTIONS  
DEPARTMENT OF TRAINING AND PLACEMENTS  
COMPARATIVE STATEMENT OF TRAINING VENDORS

Name of Training Agency	Trainer Profile and Rating					Training Cost / Student / Hour
	1	2	3	4	5	
	Name	Qualification	Professional Experience	Specialization	Rating and Remarks	
AUDAZ	Asgar Pasha	B.Sc MBA HR	18 years	Personality Development	3+5 = 8	AVG Score - 33/4 = 8.25 (Offline) = 20.5/Student/Hr + GST
	Bellapa	B.E M.Tech	30 year	Soft Skills	4+5 = 9	
	Parvathi	B.A.M.A. MBA HR	18 years	Personality Development	3+5 = 8	
	Kavitha M	B.Sc (Physics, Maths & Electronics) M.Sc (Maths)	20 years	Aptitude & Soft Skills	3+5 = 8	
Assessment Portal-Own portal available					33	
BIZOTIC	SRINATH SETHURAMAN	M.Sc, MBA (UK)	20 Years	Soft Skills and Verbal	3+5 = 8	AVG Score - 33/4 = 8.25 (Offline) = 20/Student/Hr + GST
	VINEET MANN	B.Sc, M.Sc	15 Years	Aptitude	3+5 = 8	
	SHASHIKALA MADHUSUDHAN	LLB, M.Sc	22 Years	Soft Skills and Verbal	3+5 = 8	
	K KRISHNA BAI	B.E, M.Tech (BSP)	10 Years	Technical & Aptitude	4+5 = 9	
Assessment - Own Portal Available					33	
Quan Tech Origin	Deepak P.N	B.E, M.E	08 Years	English and Soft skills	3+4 = 7	AVG Score - 25/4 = 6.25 (Offline) = 20/Student/Hr + GST
	SAMUEL JOHN	Diploma (counselling skills), B.A	12 Years	Communication and Soft Skills	1+5 = 6	
	Vignesh M.K	B.E	6 Years	Aptitude	2+3 = 5	
	Ananth P	B.E	15 Years	Technical & Aptitude	2 + 5 = 7	
Assessment - Own Portal						

III Sem (KSIT + KSSE)

17 + 02 sl

V Sem (KSIT + KSSE)

20 + 03 sl  
K. Govind  
15/10/20

X





K S GROUP OF INSTITUTIONS  
DEPARTMENT OF TRAINING AND PLACEMENTS  
COMPARATIVE STATEMENT OF TRAINING VENDORS

Name of Training Agency	Trainer Profile and Rating					Training Cost / Student / Hour
	1	2	3	4	5	
	Name	Qualification	Professional Experience	Specialization	Rating and Remarks	
AUDAZ	Asgar Pacha	B.Sc MBA HR	18 years	Personality Development	3+5 = 8	AVG Score - $33/4 = 8.25$ (Offline) = 20.5/Student/Hr + GST
	Bellapa	B.E. M.Tech.	30 year	Soft Skills	4+5 = 9	
	Parvathi	B.A.M.A. MBA HR	18 years	Personality Development	3+5 = 8	
	Kavitha M	B.Sc (Physics, Maths & Electronics) M.sc (Maths)	20 years	Aptitude & Soft Skills	3+5 = 8	
Assessment Portal-Own portal available					33	

116 Same (KSIIT + KSGI)

17 + 0.25

BIZOTIC	SRINATH SETHURAMAN	M.Sc, MBA (UK)	20 Years	Soft Skills and Verbal	3+5 = 8	AVG Score - $33/4 = 8.25$ (Offline) = 20/Student/Hr + GST
	VINEET MANN	B.Sc, M.Sc	15 Years	Aptitude	3+5 = 8	
	SHASHIKALA MADHUSUDHAN	LLB, M.Sc	22 Years	Soft Skills and Verbal	3+5 = 8	
	K KRISHNA BAI	B.E, M.Tech (BSP)	10 Years	Technical & Aptitude	4+5 = 9	
Assessment- Own Portal Available					33	

12 Same (KSIIT + KSGI)

20 + 0.25

K. Ganesha 20/10/12

Quan Tech Origin	Deepak P.N	B.E, M.E	08 Years	English and Soft skills	3+4 = 7	AVG Score - $25/4 = 6.25$ (Offline) = 20/Student/Hr + GST
	SAMUEL JOHN	Diploma (counseling skills), B.A	12 Years	Communication and Soft Skills	1+5 = 6	
	Vignesh M.K.	B.E	6 Years	Aptitude	2+3 = 5	
	Ananth P	B.E	15 Years	Technical & Aptitude	2 + 5 = 7	
Assessment- Own Portal Available					25	

+

Transit	Diana D	B.Sc. ME, PGDBA	22 Years	Behavior skills, Aptitude	4+5=9	AVG Score - 28/4 = 7 (Offline) = 23/Student/Hr + GST
	Sowmya Karat	D.E	08 Years	Aptitude	2+4=6	
	AMIT MONDLE		20 Years	Personality Development	2+3=5	
	Arun Kumar	M.Sc, MBA	17 Years	Technical & Aptitude	3+5=8	
Assessment - Skill Under Development					28	

MBA (I & II year)  
19+GST ✓

Skill Factory	Raghavan	B.Com & MBA (HR)	14 Years	Soft Skills and Verbal Skills	3+5=8	AVG Score - 33/4 = 8.25 ✓ (Offline) = 21/Student/Hr + GST
	Nisha	B.Com & MBA (Fin)	10 Years	Logical, Analytical and Verbal	3+5=8	
	Dr. Jacob S.	Ph.D	34 Years	Placement oriented train, verbal skills	5+5=10	
	Narasimha	B.E. (Information Science) & MBA (HR)	8 Years	Logical, Analytical and Verbal	3+4=7	
Assessment - Skill Under Development					33	

(KSIT + KSSeri)  
VII Semester  
20+GST 18%  
helps more

Universal Education	Avibek Ghosh	B.Sc, MBA	12 Years	Aptitude and Reasoning	3+5=8	AVG Score - 34/4 = 8.5 ✓ (Offline) = 22/Student/Hr + GST
	V Mandira Nair	B.Sc, MBA	12 Years	Verbal and communication skills	3+3=6	
	Ahankha Ghosh	B.E, MBA	12 Years	Aptitude and Reasoning	4+5=9	
	Tigrao Gulia	B.E, M.Tech	12 Years	Technical Trainer	4+3=7	
Assessment - Skill Under Development					34	

JV Global	Daschan D V	B.E, Mech	6 Years	Quantitative & Analytical	4+3=7	AVG Score - 31/4 = 7.75 ✓ (Offline) = 25/Student/Hr + GST
	Shravan A P	BA, MA	10 Years	Soft skills	4+4=8	
	Beema N	B.Sc, PG, MS, PGDBA	18 Years	Pre Placement Topics	4+5=9	
	Beema S	BE, Mech	6 Years	Quantitative & Analytical	4+3=7	
Assessment - Skill Under Development					31	

Pentagon Space	Yashwanth K N	BBM, MBA	6 Years	Verbal and communication skills	3+3=6	AVG Score - 30/4 = 7.50 ✓ (Offline) = 32/Student/Hr + GST
	Hanu R	BE, M.Tech	08 Years	Technical Trainer	4+4=8	
	DASHRATH MESAL	B.Com, MA	15 Years	Soft skills and english	3+5=8	
	ARCHANA M S	B.Com, MBA	13 Years	Soft skills	3+5=8	
Assessment - Skill Under Development					30	

Call the above for negotiations.

Shubhal  
06/10/22

6/10/22



# TRANSIT

## Training & Recruitment Partner

#324, 3<sup>rd</sup> Main road, 7<sup>th</sup> Cross road, Srinivasanagar, Bangalore-560 050  
Mobile: +91 906 693 1423 | E-mail: [ranjithnk04@gmail.com](mailto:ranjithnk04@gmail.com)

Bill To:

**K S Institute of Technology**

No 14, Kanakapura Rd, Raghuvanahalli, Bangalore  
City Municipal Corporation Layout, Bengaluru,  
Karnataka 560109

Invoice No : TTRP001/23-24

Invoice Date: 14/08/2023

### TAX INVOICE

SI.NO	Product Description	No of students	Rate	Amount
1	Soft skills Training- BE II Semester	546	540	2,94,840
Amount in words: Three Lakh Forty Seven Thousand Nine Hundred and Eleven Rupees Only			Total Amount	2,94,840
			GST 18%	53,071
			Net balance to pay	3,47,911
GST Number: 29EZCPR8344R1Z7 PAN Number :EZCPR8344R Bank details : TRANSIT- Training and Recruitment Partner Account No : 120002825715 IFSC Code: CNRB0000473 Please Make all checks payables to above mentioned details			For TRANSIT  <b>For TRANSIT</b> Training And Recruitment Partner  Ranjith NK (Proprietor) Authorized Signatory	

THANK YOU!



Skumar  
18/8/23

18/8/23  
CHIEF EXECUTIVE OFFICER  
Member Secretary  
Academic Advisory Board  
K.S. Group of Institutions

22/08/23



**KSIT**  
K.S. INSTITUTE OF TECHNOLOGY

Kammavari Sangham (R) 1952  
K.S. GROUP OF INSTITUTIONS

ಕೆ.ಎಸ್. ತಾಂತ್ರಿಕ ಮಹಾವಿದ್ಯಾಲಯ

**K.S. INSTITUTE OF TECHNOLOGY**

Accredited By NAAC

# 14, Raghuvanahalli, Kanakapura Road, Bengaluru - 560 109.

Tel : 080 28435722 / 24, Fax : 080 28435723

E-mail : principal.ksit@gmail.com / principal@ksit.edu.in | website : www.ksit.edu.in

Ref: KSIT/PO/2022-2023/TPO 007

Date: 02/08/2023

To,  
TRANSIT  
Training & Recruitment Partner  
#3234, 3rd Main Road, 7<sup>th</sup> Cross Road, Srinivasanagar  
Bangalore, Karnataka-560050

Dear Sir,

Sub: Purchase Order for Soft Skills Training Program for 1<sup>st</sup> year B.E Students.

With reference to the above, we are pleased to place the order for Soft Skills Training Program for 2<sup>nd</sup> Semester Students at K.S.Institute of Technology, #14, Raghuvanahalli, Kanakapura Road, Bangalore - 109 as per the following specifications, terms & conditions.

Programme Commercials:

SL.No.	Description	Quantity	Rate	Amount
1	Soft Skills Training Program for First Year B.E Students.	546	Rs. 18/Hour/Student (546 × 30Hrs × 18Rs)	2,94,840/-
	Total			2,94,840/-
	Taxable Value			
	ADD: (CGST 9% + SGST 9%) GST		18%	53,071/-
	Grand TOTAL			3,47,911/-
Amount in Words: Rupees Three Lakhs Forty Seven Thousand Nine Hundred And Eleven Only.				

Terms & Conditions:

- Training for 2<sup>nd</sup> Semester students would be from 3<sup>rd</sup>-8<sup>th</sup> July 2023.
- Full Payment to be made post satisfactory completion of the training.

Thanking you,

  
Hon. Secretary

KAMMAVARI SANGHAM

K.S. INSTITUTE OF TECHNOLOGY

Approved by AICTE , New Delhi & Affiliated to VTU, Belagavi, Karnataka





## DEPARTMENT OF TRAINING AND PLACEMENTS

### Soft Skills Training and Placements

Date of Conduction: 03-08-2023 to 08-08-2023

Venue: (NB) Class Rooms, KSIT

Time: 8.50 AM. TO 3.50 PM

Duration: 30 HOURS

### Objective of the Training Program

The sole objective of imparting Soft skills training program is to enable students to learn critical evaluation techniques and various real life situations by resorting to analyze key issues. This training program will help students to enhance the problem solving skills, improve Communication skills, discover their interests and career choices, to maximize potentialities and boosting self-confidence, understanding high demand in society and have good job prospects and to help students prepare for competitive examinations and higher studies.

### Soft Skills

Strong communication skills:- Improves the ability to speak professional English, building positive relationships with stakeholders, and showing inspiring leadership qualities – typically called “Soft Skills” – are becoming increasingly essential for degree and manufacturing professionals.

Many Degree professionals assume that their technical expertise and experience is the only thing that will get them a job. However, this is changing as engineers are increasingly expected to partner with the business, and these soft skills – when coupled with the right combination of technical skills – are in great demand, and can set them apart in a highly competitive jobs market. Soft skills are all those personal attributes that sit outside professional qualifications and work experience. They refer to how people interact, lead and communicate with other people, and they're an essential foundation for any successful career. There is no doubt about the fact that the technical skills are an absolute essential for an engineer to perform his job diligently and efficiently. The fact that the second skill set, that is, the soft skills along with the hard skills are an absolute essential for growth of an engineer in the organization. A blend of both is what determines their level of success as a professional. A soft skill is not just limited to the workplace of a professional but extends to other spheres of their life too for example social and family.

Soft skills is not just about communicating, but includes ability to manage stress, ability to organize, ability to provide solutions. Most of the times the importance of soft skills is ignored and not given adequate attention for engineers. The education that goes in to make an engineer does not concentrate on the people skills. The curriculum tends to ignore the fact that at the end of the day an engineer would be working in a team, reporting to someone, taking reports, dealing with work pressures, giving presentations, attending phone calls, sending mails just to specify a few. In all such situations along with technical skills, experience and physiological maturity of an individual is going to play an important role.







		Batch 01	Batch 02	Batch 03	Batch 04	Batch 05	Batch 06	Batch 07	Batch 08	Batch 09
		CS A	CS B	CS C	CSD	AIML	EC A	EC B	101	CCF+ME
		101	102	104	202	203	205	J01	302	304
Thursday 03-Aug-23	S1	Sam	Vedavathi	Shiva	Jhanavi	Ashfak	Arun Sax	Srinath	Imran	Panchami
	S2	Work Culture	Adaptability	Stress Management	Conflict Resolution	Letter Email LinkedIn	Problem Solving	SWOT Analysis	Confidence Building	Active Listening
	S3	Panchami	Sam	Vedavathi	Shiva	Jhanavi	Ashfak	Arun Sax	Srinath	Imran
	S4	Active Listening	Work Culture	Adaptability	Stress Management	Conflict resolution	Letter Email LinkedIn	Problem Solving	SWOT Analysis	Confidence Building
Friday 04-Aug-23	S1	Imran	Panchami	Sam	Vedavathi	Shiva	Jhanavi	Ashfak	Arun Sax	Srinath
	S2	Confidence Building	Active Listening	Work Culture	Adaptability	Stress Management	Conflict resolution	Letter Email LinkedIn	Problem Solving	SWOT Analysis
	S3	Srinath	Imran	Panchami	Sam	Vedavathi	Shiva	Jhanavi	Ashfak	Arun Sax
	S4	SWOT Analysis	Confidence building	Active Listening	Work Culture	Adaptability	Stress Management	Conflict resolution	Letter Email LinkedIn	Problem Solving
Saturday 05-Aug-23	S1	Arun Sax	Srinath	Imran	Panchami	Sam	Vedavathi	Shiva	Jhanavi	Ashfak
	S2	Problem solving	SWOT Analysis	Confidence building	Active Listening	Work Culture	Adaptability	Stress Management	Conflict resolution	Letter Email LinkedIn
	S3	Ashfak	Arun Sax	Srinath	Imran	Panchami	Sam	Vedavathi	Shiva	Jhanavi
	S4	Letter Email LinkedIn	Problem Solving	SWOT Analysis	Confidence building	Active Listening	Work Culture	Adaptability	Stress Management	Conflict Resolution
Monday 07-Aug-23	S1	Jhanavi	Prem	Arun Sax	Srinath	Imran	Panchami	Ajay	Vedavathi	Shiva
	S2	Conflict resolution	Professionalism	Problem Solving	SWOT Analysis	Confidence building	Active Listening	Intrapersonal skills	Adaptability	Stress Management
	S3	Shiva	Jhanavi	Prem	Arun Sax	Srinath	Imran	Panchami	Ajay	Vedavathi
	S4	Stress Management	Conflict resolution	Professionalism	Problem Solving	SWOT Analysis	Confidence building	Active Listening	Intrapersonal skills	Adaptability
Tuesday 08-Aug-23	S1	Vedavathi	Shiva	Jhanavi	Prem	Arun Sax	Srinath	Imran	Panchami	Ajay
	S2	Adaptability	Stress Management	Conflict resolution	Professionalism	Problem Solving	SWOT Analysis	Confidence building	Active Listening	Intrapersonal skills
	S3	Ajay	Ashfak	Shiva	Jhanavi	Prem	Arun Sax	Srinath	Imran	Panchami
	S4	Intrapersonal skills	Letter Email LinkedIn	Communication skills 2	Grooming	Professionalism	Decision Making	Emotional Intelligence	Grooming	Communication skills 2
Wednesday 09-Aug-23	S1	Panchami	Ajay	Ashfak	Shiva	Jhanavi	Prem	Arun Sax	Srinath	Imran
	S2	Communication skills 2	Intrapersonal skills	Letter Email LinkedIn	Communication skills 2	Grooming	Professionalism	Decision Making	Emotional Intelligence	Grooming
	S3	Imran	Panchami	Ajay	Ashfak	Shiva	Jhanavi	Prem	Arun Sax	Srinath
	S4	Grooming	Communication skills 2	Intrapersonal skills	Letter Email LinkedIn	Communication skills 2	Grooming	Professionalism	Decision Making	Emotional Intelligence
Thursday 10-Aug-23	S1	Srinath	Imran	Panchami	Ajay	Vedavathi	Shiva	Sam	Prem	Arun Sax
	S2	Emotional Intelligence	Grooming	Decision Making	Intrapersonal skills	Emotional Intelligence	Communication skills 2	Work Culture	Professionalism	Decision Making
	S3	Arun Sax	Jhanavi	Imran	Panchami	Ajay	Vedavathi	Shiva	Sam	Prem
	S4	Decision Making	Emotional Intelligence	Grooming	Decision Making	Intrapersonal skills	Emotional Intelligence	Communication skills 2	Work Culture	Professionalism
Friday 11-Aug-23	S1	Prem	Arun Sax	Srinath	Imran	Panchami	Ajay	Jhanavi	Shiva	Sam
	S2	Professionalism	Decision Making	Emotional Intelligence	Emotional Intelligence	Decision Making	Intrapersonal skills	Emotional Intelligence	Communication skills 2	Work Culture

**Outcomes / Benefits:**

Students are able to apply soft skills in multidisciplinary applications.

**PO Mapping:**

PO	PO1	PO2	PO3	PO4	PO5	PO6	PO7	PO8	PO9	PO10	PO11	PO12
Soft skill training and Placements				2					3	3		3

*Shyloja K.R.*  
Coordinator



*Shyloja K.R.*  
Principal  
PRINCIPAL  
K.S. INSTITUTE OF TECHNOLOGY  
BENGALURU - 560 109.





**AXIS BANK LTD**

PHASE 6TH PHASE BANGALORE IN, BANGALURU, 560076  
IFS CODE - UTIB0001013

**A/c. PAYEE ONLY**

VALID FOR THREE MONTHS FROM THE DATE OF ISSUE

DATE: 08 11 20 22  
FORM: D D M M Y Y Y Y

Pay **Audaz Ventures Pvt Ltd**

OR BEARER / या धारक को

रुपये Rupees **One lakh seventy six thousand  
eight hundred seven only**

₹ **1,76,807/-**

A/C NO. 912010014093916

For K S INSTITUTE OF TECHNOLOGY

FLTRS 000180

*[Signature]*  
Authorized Signatory(ies)

Please sign above

Payable at par at all branches of Axis Bank Ltd in India.

⑈ 224436⑈ 5602⑈ 034⑈ 000⑈ 60⑈ 3⑈

*Received  
Asst.  
12/11/22*

REISSUANCE QTR - 2018 - 23/07/2022 5142877



**K S GROUP OF INSTITUTIONS**  
**DEPARTMENT OF TRAINING AND PLACEMENTS**  
**COMPARATIVE STATEMENT OF TRAINING VENDORS**

Name of Training Agency	Trainer Profile and Rating					Training Cost / Student / Hour
	1 Name	2 Qualification	3 Professional Experience	4 Specialization	5 Rating and Remarks	
AUDAZ	Asgar Pasha	B.Sc MBA HR	18 years	Personality Development	3+5 = 8	AVG Score - 33/4 = 8.25 (Offline) = 20.5/Student/Hr + GST
	Bellipta	B.E. M.Tech.	30 year	Soft Skills	4+5 = 9	
	Parvathi	B.A.M.A. MBA HR	18 years	Personality Development	3+5 = 8	
	Kavitha M	B.Sc (Physics, Statistics) (Electronics) M.Sc (Maths)	20 years	Aptitude & Soft Skills	3+5 = 8	
Assessment Portal-Own portal available					33	

III Sem (KSIIT, KSSE)

17 + 07 = 24

BIZOTIC	SRENATH SETHURAMAN	M.Sc, MBA (UK)	20 Years	Soft Skills and Verbal	3+5 = 8	AVG score - 33/4 = 8.25 (Offline) = 20.5/Student/Hr + GST
	VINEET MANN	B.Sc / M.Sc	15 Years	Aptitude	3+5 = 8	
	SHASHIKALA MADHUSUDHAN	LL.B, M.Sc	22 Years	Soft Skills and Verbal	3+5 = 8	
	K.KRISHNA BAI	B.E, M.Tech (BSP)	10 Years	Technical & Aptitude	4+5 = 9	
Assessment - Own Portal Available					33	

IV Sem (KSIIT, KSSE)

20 + 03 = 23  
 K. Ganga  
 20/10/22

Quan Tech Origin	Deepak P.N	B.E, M.E	08 Years	English and Soft skills	3+4 = 7	AVG Score - 25/4 = 6.25 (Offline) = 20/Student/Hr + GST
	SAMUEL JOHN	Diploma (counselling skills), B.A	12 Years	Communication and Soft Skills	3+5 = 6	
	Vignesh M.K.	B.E	6 Years	Aptitude	2+3 = 5	
	Arunb P	B.E	15 Years	Technical & Aptitude	2 + 5 = 7	
Assessment - Own Portal Available					25	

+





**KSIT**  
K.S. INSTITUTE OF TECHNOLOGY

Kammavari Sangham (R) 1952  
K.S. GROUP OF INSTITUTIONS

ಕೆ.ಎಸ್. ತಾಂತ್ರಿಕ ಮಹಾವಿದ್ಯಾಲಯ

**K.S. INSTITUTE OF TECHNOLOGY**

Accredited By NAAC

# 14, Raghuvanahalli, Kanakapura Road, Bengaluru - 560 109.

Tel : 080 28435722 / 24, Fax : 080 28435723

E-mail : principal.ksit@gmail.com / principal@ksit.edu.in | website : www.ksit.edu.in

Ref: KSIT/PO/2022-2023/TPO 005

Date: 01/10/2022

To,  
Audaz Ventures Private Ltd.  
C-2-C-2/100, Janakpuri, South West Delhi - 110058

Dear Sir,

**Sub: Purchase Order for Internship Program for 3<sup>rd</sup> Semester B.E Students.**

With reference to the above, we are pleased to place the order for **Internship Program** for 3<sup>rd</sup> Semester Students at **K.S. Institute of Technology**, #14, Raghuvanahalli, Kanakapura Road, Bangalore – 109 as per the following specifications, terms & conditions.

**Programme Commercials:**

Sl.No.	Description	Quantity	Rate	Amount
1	Internship Program for III Semester B.E Students	321	Rs. 17/Hour/Student (321 × 30Hrs × 17Rs)	1,63,710/-
	Total			1,63,710/-
	Taxable Value			29,467.80/-
	ADD: CGST 9%			14,733.9/-
	ADD: SGST 9%			14,733.9/-
	<b>Grand TOTAL</b>			<b>1,93,178.35/-</b>
<u>Amount in Words:</u> Rupees One Lakh Ninety Three Thousand One Hundred Seventy Eight Only				

**Terms & Conditions:**

- Internship dates for 3<sup>rd</sup> Semester students would be from 11<sup>th</sup> – 15<sup>th</sup> October 2022.
- Full Payment to be made post satisfactory completion of the training.

Thanking you,

  
Hon. Secretary 07/11/22

KAMMAVARI SANGHAM









# K. S INSTITUTE OF TECHNOLOGY, BENGALURU

14, Kanakapura Main Road, Raghuvanahalli, Bengaluru, Karnataka - 560109

## \*\* DEPARTMENT OF TRAINING AND PLACEMENTS \*\*

08.10.2022

### INTERNSHIP PROGRAM FOR 3<sup>rd</sup> SEMESTER STUDENTS

Placement Department has planned to conduct **Mandatory Internship Program** suggested by VTU, for 3<sup>rd</sup> Semester students starting from 11/10/2022 to 15/10/2022 from 8.50 AM to 4.00 PM. HODs of respective departments are hereby requested to communicate their 3<sup>rd</sup> Semester students regarding the same.

The training will be conducted in old building Ground and First floor. Respective **Class Teachers** are **requested** to take the attendance in the first 15 minutes only in all the sessions and to submit the consolidated **attendance on all 5 days** to Placement Department. Batch wise schedule is given below for your reference.

DATE	TIME	BATCH	BATCH	BATCH	BATCH	BATCH	BATCH
		1	2	3	4	5	6
		CSE (A)	CSE (B)	ECE (A)	ECE (B)	CSD	AIML+ME
11 <sup>th</sup> to 15 <sup>th</sup> October 2022	8.50AM -11.00AM	OB-007	OB-008	OB - 101	OB - 203	OB - 105	OB - 106
	11.00AM - 11.15AM	BREAK					
	11.15AM - 1.15PM	OB-007	OB-008	OB - 101	OB - 203	OB - 105	OB - 106
	1.15PM - 1.50PM	LUNCH BREAK					
	1.50PM - 4.00PM	OB-007	OB-008	OB - 101	OB - 203	OB - 105	OB - 106

#### NOTE:

- Students are strictly informed to be present in their allocated rooms only for all the five days. **DO NOT SWAP THE BATCHES.**
- Feedback QR code will be displayed in all the training rooms. **Students are informed to provide the feedback for each session before leaving the class.**
- Credits and Certificates will be given to those students who will have 95% attendance.

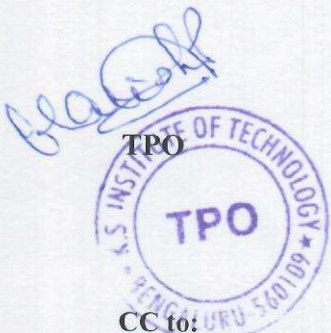

CC to:

HODs and Coordinators of:

CSE	ECE	ME	CSD	AIML	BS & H
-----	-----	----	-----	------	--------

  
 PRINCIPAL  
 PRINCIPAL  
 K.S. INSTITUTE OF TECHNOLOGY  
 BENGALURU - 560 109.



# K.S.INSTITUTE OF TECHNOLOGY

## Department of Training and Placements

INTERNSHIP PROGRAM \_3rd Semester

**BATCH 1** -COMPUTER SCIENCE & ENGINEERING (**OB-007**)

SL.NO	USN	NAME OF THE STUDENT
1	1KS21CS001	A RAMYASREE
2	1KS21CS002	AARYA M
3	1KS21CS003	ABHILASHA V
4	1KS21CS004	ABHIRAM K
5	1KS21CS005	ABHIRAM YADATORE SHANTARAM
6	1KS21CS006	ADITHI R
7	1KS21CS007	ADITHI S REDDY
8	1KS21CS008	ADITYA V
9	1KS21CS009	AFIFAH AYESHA BIJLI
10	1KS21CS010	AISHWARYA G
11	1KS21CS011	AKSHAY VIVEKANANDA B
12	1KS21CS012	ANANYA PRASAD S
13	1KS21CS014	ARCHANA P
14	1KS21CS015	ARTHAN M GOWDA
15	1KS21CS016	ASHA H P
16	1KS21CS017	ASHWINI
17	1KS21CS018	B G PRAJWAL
18	1KS21CS020	BHAVANA B
19	1KS21CS021	CHAITRA M
20	1KS21CS022	CHARISHMA A
21	1KS21CS023	CHARISHMA M
22	1KS21CS024	CHETHAN H
23	1KS21CS025	DARSHAN S
24	1KS21CS026	DEEPTHI A B
25	1KS21CS027	DHRUTHI UMESH S
26	1KS21CS028	D L SHIVANG
27	1KS21CS029	GAANA S
28	1KS21CS030	GAGAN SHIVANNA
29	1KS21CS031	GOPALA KRISHNA V
30	1KS21CS032	GURUPRASAD Y S
31	1KS21CS033	HARSHITHA K M
32	1KS21CS034	HARSHITHA P



SL.NO	USN	NAME OF THE STUDENT
33	1KS21CS035	HARSHITHA R
34	1KS21CS036	HARSHITHA S
35	1KS21CS037	HARSHITHA S
36	1KS21CS038	HEMANTH KUMAR V
37	1KS21CS039	HRITHIKA V
38	1KS21CS040	IBBANI V GOWDA
39	1KS21CS041	IMAN GHORAI
40	1KS21CS042	JAHNAVI P
41	1KS21CS043	JASHWANTH P C
42	1KS21CS044	K MEGHANA
43	1KS21CS045	KANISHK E R
44	1KS21CS046	KARTHIK H N
45	1KS21CS047	KAUSHIK G V
46	1KS21CS048	KAVANA N
47	1KS21CS049	KAVYA B SINGH
48	1KS21CS050	KEERTHIKA S
49	1KS21CS051	KONGARA SREE SAI
50	1KS21CS052	KUNAPALLI LAASYASHRRE
51	1KS21CS053	L.LAVANYA
52	1KS21CS054	M VAIBHAV NAYAK
53	1KS21CS055	MADHU SNEHA SHREE S
54	1KS21CS056	MANIKANTH
55	1KS21CS057	MANJUNATH
56	1KS21CS058	MANOJ KUMAR S
57	1KS21CS059	MAUSAM KUMAR
58	1KS21CS060	MAYA



*(Signature)*  
 PRINCIPAL  
 K.S. INSTITUTE OF TECHNOLOGY  
 BENGALURU - 560 109.



# K.S.INSTITUTE OF TECHNOLOGY

## Department of Training and Placements

INTERNSHIP PROGRAM \_3rd Semester

**BATCH 2 -COMPUTER SCIENCE & ENGINEERING (OB -008)**

SL.NO	USN	NAME OF THE STUDENT
1	1KS21CS061	MONIKA D
2	1KS21CS062	N VIDYASAGAR
3	1KS21CS063	NAGADARSHAN R P
4	1KS21CS064	NAGASHREE A
5	1KS21CS065	NAREN RAKSHITH K V
6	1KS21CS066	NETYAM SHIVSARAN
7	1KS21CS067	NIKHIL SAI K V
8	1KS21CS068	NOOR ZAHIDA
9	1KS21CS069	OMKAR ARJUN MAGADUM
10	1KS21CS070	POOJA G
11	1KS21CS071	POOJITHA M V
12	1KS21CS072	POOJITHA R
13	1KS21CS073	PRANAY G
14	1KS21CS074	PRIYANKA V
15	1KS21CS075	R AISHWARYA
16	1KS21CS076	R HARSHA
17	1KS21CS077	RAKSHITA G SATARADDI
18	1KS21CS078	RAKSHITHA D H
19	1KS21CS079	RASHMI B PHULARI
20	1KS21CS080	RAVEESH PRASAD M
21	1KS21CS081	RAVITEJ ARJUN KAKHANDAKI
22	1KS21CS082	REDDY TEJASWINI A
23	1KS21CS083	RUSHIKESH B
24	1KS21CS084	RUTHU M R
25	1KS21CS085	SAGAR S N
26	1KS21CS086	SAMRAT SINGH
27	1KS21CS087	SANTHOSH K A
28	1KS21CS088	SHAMITHA RAVISHANKAR
29	1KS21CS089	SHEETAL NAIK
30	1KS21CS090	SHEETHAL G
31	1KS21CS091	SHEETHAL R
32	1KS21CS092	SHOEB AHMED QUADRI



SL.NO	USN	NAME OF THE STUDENT
33	1KS21CS093	SHREYAS C
34	1KS21CS094	SINDHU MEGHA
35	1KS21CS095	SKANDA KUMAR H S
36	1KS21CS096	SNEHA S
37	1KS21CS097	SOUJANYA N
38	1KS21CS098	SRINIDHI MADHUSUDHAN
39	1KS21CS099	SUMAN B S
40	1KS21CS100	SUMEDHA R
41	1KS21CS101	SUMUKHA S BHARADWAJ
42	1KS21CS102	SUNIDHI P
43	1KS21CS103	SURESH C
44	1KS21CS104	SUSHMITHA M
45	1KS21CS105	SWAROOP S KOWSHIK
46	1KS21CS106	TEJASHREE GOWDA Y K
47	1KS21CS107	UJWAL M L
48	1KS21CS108	V M TEJUS
49	1KS21CS109	VAISHALI BHOSLE
50	1KS21CS110	VANISHREE
51	1KS21CS111	VARSHA H R
52	1KS21CS112	VARUN SAI V
53	1KS21CS113	VIBHA GOVIN S
54	1KS21CS114	VIJETHA S
55	1KS21CS115	VILAS V
56	1KS21CS116	VISHAL KAMAN
57	1KS21CS117	YASHAS D GOWDA
58	1KS21CS118	YASHASHWINI R

*Principals*  
 PRINCIPAL  
 K.S. INSTITUTE OF TECHNOLOGY  
 BENGALURU - 560 109.





# K.S.INSTITUTE OF TECHNOLOGY

Department of Training and Placements

INTERNSHIP PROGRAM \_3rd Semester

**BATCH 3 -ELECTRONICS AND COMMUNICATION ENG (OB -101)**

SL.NO	USN	NAME OF THE STUDENT
1	1KS21EC001	AADHYA B N
2	1KS21EC002	ABHIJITH R
3	1KS21EC003	ABHISHEK H C
4	1KS21EC004	ABHISHEK T S
5	1KS21EC005	AISHWARYA A
6	1KS21EC006	AKSHAY C
7	1KS21EC007	AKSHAY M S
8	1KS21EC008	ANAGHA PRAKASH
9	1KS21EC009	ANIRUDHA R BHAT
10	1KS21EC010	ARCHANA G M
11	1KS21EC011	ARCHANA M
12	1KS21EC012	ARJUN BHARADWAJ
13	1KS21EC013	ASHCHARYA N B
14	1KS21EC014	ASHWIN S R
15	1KS21EC015	B N JEEVAN
16	1KS21EC016	B P SAMARTH
17	1KS21EC017	B S BHARGAV
18	1KS21EC018	BHAVYA K
19	1KS21EC019	BHUVANA H
20	1KS21EC020	BINDUSHREE S
21	1KS21EC021	CHINTAN D S
22	1KS21EC022	CHIRAG S
23	1KS21EC023	CHIRANTH V V
24	1KS21EC024	DAGGUPATI CHARITHA
25	1KS21EC025	DAMINI S
26	1KS21EC026	DEEKSHA H K
27	1KS21EC027	DEEPIKA D
28	1KS21EC028	GAGAN V
29	1KS21EC029	GAGANA SINDHU N
30	1KS21EC030	GREESHMA S
31	1KS21EC031	GURUSHANKARA M
32	1KS21EC032	HARINI.L
33	1KS21EC033	HEMANTH D R
34	1KS21EC035	KAMBHAMPATI VIVEK



SL.NO	USN	NAME OF THE STUDENT
35	1KS21EC036	KARAN S
36	1KS21EC037	KEERTHANA S
37	1KS21EC038	KOMALA N
38	1KS21EC039	KUSHAL GOWDA U
39	1KS21EC040	KUSUMA M S
40	1KS21EC041	LIKITHA L
41	1KS21EC042	LOHIT HOOLAGERI
42	1KS21EC043	LOHITH B
43	1KS21EC044	LOHITH S
44	1KS21EC045	MANOJ T V
45	1KS21EC046	MEGHANA N
46	1KS21EC047	MISBA M
47	1KS21EC048	MITHUN C
48	1KS21EC049	MONISHA D
49	1KS21EC050	MUTTHULURU SAI HIMAJA
50	1KS21EC051	NANDAN K
51	1KS21EC052	NANDAN P B
52	1KS21EC053	NARAHARI N JOSHI
53	1KS21EC054	NAVEEN S
54	1KS21EC055	NAYANA J
55	1KS21EC056	NAYANA S
56	1KS21EC057	NIDHI R
57	1KS21EC058	OMKAR N BHUJARKAR
58	1KS21EC059	PAVAN M PAI
59	1KS21EC060	POLURU MANJUNATH



*D. Kumar. S.*  
 PRINCIPAL  
 K.S. INSTITUTE OF TECHNOLOGY  
 BENGALURU - 560 109.



# K.S.INSTITUTE OF TECHNOLOGY

Department of Training and Placements

INTERNSHIP PROGRAM \_3rd Semester

**BATCH 4** -ELECTRONICS AND COMMUNICATION ENG (**OB -104**)

SL.NO	USN	NAME OF THE STUDENT
1	1KS21EC061	POOJA R
2	1KS21EC062	PRAJWAL D
3	1KS21EC063	PRAJWAL G V
4	1KS21EC064	PRAJWAL H S
5	1KS21EC065	PRAJWAL R
6	1KS21EC066	PRATHAM R SHANBHAG
7	1KS21EC067	PRAYAG SINGH S
8	1KS21EC068	PREETHAM M
9	1KS21EC069	PREKSHA S
10	1KS21EC070	PUNITH M
11	1KS21EC071	RAGHAVENDRA NARAYAN PUJAR
12	1KS21EC072	RAKSHITH S
13	1KS21EC073	RAKSHITHA M R
14	1KS21EC074	RAYADURG JOISH SHRIYA
15	1KS21EC075	REHAMAN SHARIFF
16	1KS21EC076	RITESH KUMAR SINHA
17	1KS21EC077	RITHIKA M
18	1KS21EC078	S HARI DHANUSH
19	1KS21EC080	S. SHAJITH ALI
20	1KS21EC081	SAGAR G S
21	1KS21EC082	SAI RAHUL N
22	1KS21EC083	SAMHITHA PRAKASH
23	1KS21EC084	SANJANA V
24	1KS21EC085	SANJAY G
25	1KS21EC086	SANJAY N
26	1KS21EC087	SANJAY P
27	1KS21EC088	SATHYAM KUMAR MANDAL S
28	1KS21EC089	SHAIK ARFATH
29	1KS21EC090	SHASHANK C U
30	1KS21EC091	SHREYAS RAGHAVENDRA V
31	1KS21EC092	SHWETHA V
32	1KS21EC093	SINDHU M NIMBAL
33	1KS21EC095	SPOORTHY M U
34	1KS21EC096	SRILAKSHMI G



SL.NO	USN	NAME OF THE STUDENT
35	1KS21EC097	SRIPRIYA H G
36	1KS21EC098	SUMUKH P
37	1KS21EC099	SUNEETHA
38	1KS21EC100	SUNEHA S
39	1KS21EC101	SUPREETH A
40	1KS21EC102	SURABHI K R
41	1KS21EC103	SUSHEN KRISHNAPUR
42	1KS21EC104	TARUN M
43	1KS21EC105	TEJASHREE N
44	1KS21EC106	THARUN K V
45	1KS21EC107	THEJAS H V
46	1KS21EC108	THUSHAR CHERIAN
47	1KS21EC109	UDAYA KUMAR S R
48	1KS21EC110	VAISHNAVI B A
49	1KS21EC111	VARSHA JAYAKUMAR
50	1KS21EC112	VARSHA S DAVASKAR
51	1KS21EC113	VARSHITH S
52	1KS21EC114	VEERESH K N
53	1KS21EC115	VIDYA I
54	1KS21EC116	VIDYA RAWAL D
55	1KS21EC117	VIDYASHREE R
56	1KS21EC118	VIJAY YADAV R
57	1KS21EC120	VYSHAK G R
58	1KS21EC121	YASHWANTH.M



*Prakash G*  
 PRINCIPAL  
 K.S. INSTITUTE OF TECHNOLOGY  
 BENGALURU - 560 109.



# K.S.INSTITUTE OF TECHNOLOGY

Department of Training and Placements

INTERNSHIP PROGRAM \_3rd Semester

**BATCH 5 -COMPUTER SCIENCE AND DESIGN (OB - 105)**

SL.NO	USN	NAME OF THE STUDENT
1	1KS21CG001	A S N SREEYA
2	1KS21CG002	ABDUS SALAAM I
3	1KS21CG003	ABHILASHA PATIL
4	1KS21CG004	ANAGHA SHASTRY
5	1KS21CG005	ANKITHA DEVLOKAM
6	1KS21CG006	ARPITHA G R
7	1KS21CG007	B H RUCHIRA
8	1KS21CG008	BADARI PRASAD M
9	1KS21CG009	BHARAT R
10	1KS21CG010	BUDEN GOUDA
11	1KS21CG011	CHALLA DEEPIKA
12	1KS21CG012	DANDA AJITH KUMAR
13	1KS21CG013	DEEPIKA S
14	1KS21CG014	DEEPTHI G B
15	1KS21CG015	DHANUSH B K
16	1KS21CG016	DIVYA T
17	1KS21CG017	G PRADEEP
18	1KS21CG018	G YOGIRAM
19	1KS21CG019	GOVIND VENKATESHA SHETTY
20	1KS21CG020	HEMANTH M
21	1KS21CG021	KARTHIK C S
22	1KS21CG022	KEERTHANA LOKESH
23	1KS21CG023	KEERTHANA S
24	1KS21CG024	KEERTHANA S D
25	1KS21CG025	KUSHAL M J
26	1KS21CG026	KUSUM PAKIRA
27	1KS21CG027	MONISHA M
28	1KS21CG028	NEHA M R



SL.NO	USN	NAME OF THE STUDENT
29	1KS21CG029	NISHANTH G K
30	1KS21CG030	PAVITHRAA G
31	1KS21CG031	PRATEEK C HIEMATH
32	1KS21CG032	PREETHAM H V
33	1KS21CG033	RAYALA SAI PRAKASH
34	1KS21CG034	RIYA NAIR
35	1KS21CG035	SANJANA SREENIVAS
36	1KS21CG036	SANJANA V
37	1KS21CG037	SANJAY P
38	1KS21CG038	SATHYA SAI SRI B S
39	1KS21CG039	SAVYASHREE S
40	1KS21CG040	SHALINI B
41	1KS21CG041	SHISHIRA MOHAN
42	1KS21CG042	SHIVANI ADHIKARI
43	1KS21CG043	SHREYAS G
44	1KS21CG044	SHREYAS M
45	1KS21CG045	SHRUTHI K RAJ
46	1KS21CG046	SUDARSHAN BABU A
47	1KS21CG047	SUMANA R
48	1KS21CG048	SUMANTH V SHET
49	1KS21CG049	TARUN JANGIR
50	1KS21CG050	THANUJA B
51	1KS21CG051	THEJAS B S
52	1KS21CG052	UNUGURU GIRI SANKAR
53	1KS21CG053	VAISHNAVI S
54	1KS21CG054	VARSHITHA S
55	1KS21CG055	VARSHITHA SRIDHAR
56	1KS21CG056	VIDHEESHA T M
57	1KS21CG057	VIGNESH U
58	1KS21CG058	VYSHNAVI S N
59	1KS21CG059	YEDDULAPALLI SAHITHI



*Principal*  
K.S. INSTITUTE OF TECHNOLOGY  
BENGALURU - 560 109.



# K.S.INSTITUTE OF TECHNOLOGY

## Department of Training and Placements

INTERNSHIP PROGRAM \_3rd Semester

**BATCH 6** -ARTIFICIAL INTELLIGENCE AND MACHINE LEARNING +  
MECHANICAL ENGINEERING (**OB - 106**)

SL.NO	USN	NAME OF THE STUDENT
1	1KS21AI001	ABHAY SURYA E
2	1KS21AI002	ADITHI R
3	1KS21AI003	ADITYA KALKUR
4	1KS21AI004	AMRUTHA M V
5	1KS21AI005	ANANYA B GOWDA
6	1KS21AI006	ANANYA PRAMOD
7	1KS21AI007	ANUSHREE R
8	1KS21AI008	APEKSHA I M
9	1KS21AI009	ARVIND N
10	1KS21AI010	BHUVAN S GOWDA
11	1KS21AI011	CHAITRA S
12	1KS21AI012	CHEZHAN S
13	1KS21AI013	CHIRAG V S
14	1KS21AI014	ESHWAR S
15	1KS21AI015	G C SAMBRAM
16	1KS21AI016	G VINAY KUMAR
17	1KS21AI017	HARIKRISHNA G
18	1KS21AI018	HARSHITHA A
19	1KS21AI019	HEMALATHA D R
20	1KS21AI020	JAYASHREE P R
21	1KS21AI021	K J ARUN
22	1KS21AI022	KARTHIK CHAVAN
23	1KS21AI023	KAVYA S
24	1KS21AI024	KEERTHANA R
25	1KS21AI025	LIKITHA K
26	1KS21AI026	LOCHAN K
27	1KS21AI027	LOKARANJAN B S
28	1KS21AI028	MODUPALLI MEGHANA



SL.NO	USN	NAME OF THE STUDENT
29	1KS21AI029	MRUDULA S R
30	1KS21AI030	NABIHA SHARIFF
31	1KS21AI031	NEERAJ P
32	1KS21AI032	NEHA K B
33	1KS21AI033	NILANJANA JAMINDAR
34	1KS21AI034	NITHIN HAREESH GOWDA S H
35	1KS21AI035	NITHISH GOWDA K J
36	1KS21AI036	NITHYA R
37	1KS21AI037	P LALIT SHEKHAR
38	1KS21AI038	PRAJWAL D
39	1KS21AI039	PUNYA SHREE T S
40	1KS21AI040	RACHANA P R
41	1KS21AI041	RAKSHITA S
42	1KS21AI042	SAHANA S
43	1KS21AI043	SAI NEHA D P
44	1KS21AI044	SAMANA M B
45	1KS21AI045	SANJANA O R
46	1KS21AI046	SHAMA S K
47	1KS21AI047	SHASHANK P
48	1KS21AI048	SHIVANI UPPIN
49	1KS21AI049	SUDEEP RANJAN
50	1KS21AI050	SUHAS R
51	1KS21AI051	SURABHI T G
52	1KS21AI052	TANUSHREE S
53	1KS21AI053	THRYAKSHARI S
54	1KS21AI054	VARNIKA V N
55	1KS21AI055	VENKATESH T
56	1KS21AI056	VINITH P
57	1KS21AI057	ZUHA SUHAIL
58	1KS21ME001	A ASLAM BASHA
59	1KS21ME002	DHANUSH R
60	1KS21ME003	HEMANTH H
61	1KS21ME004	K HARISH KUMAR
62	1KS21ME005	MANOJ T S



SL.NO	USN	NAME OF THE STUDENT
63	1KS21ME006	N EKANTH
64	1KS21ME007	NITHIN KUMAR P
65	1KS21ME008	PAVAN K
66	1KS21ME009	PAVANKUMAR H
67	1KS21ME010	RAJESH KUMAR N G
68	1KS21ME011	ROHIT KUMAR S



*Shreemath. G*  
PRINCIPAL  
K.S. INSTITUTE OF TECHNOLOGY  
BENGALURU - 560 109.



# AUDAZ

Audaz Ventures Pvt. Ltd.

#33, Sai Lotus, 2<sup>nd</sup> Floor, RR Nagar, Bangalore - 560098

Mobile: 9818019279

Email: info@audazlearning.com

To,

Dr. Harish R.,

Training & Placement Officer

K.S. Institute of Technology

Bengaluru, Karnataka - 560109

Dear Sir,

Please find below the detailed training & placement report for B.E. III Semester Training Program conducted from 11<sup>th</sup> October 2022 till 15<sup>th</sup> October 2022.

Report contains the following:

1. Program Objectives
2. Program Outcome
3. Trainer details
4. Modules covered

Regards,

Team Audaz



### PROGRAM OBJECTIVES

- To enable students to communicate clearly and with impact by improving their verbal and non-verbal communication.
- To enhance interpersonal skills to students.
- To enable students to build a right thought process in tough situations.
- To enable students to develop emotional intelligence

### PROGRAM OUTCOMES:

- Overcoming inferiority complex by way of presentations and other activities in the session.
- Building self confidence
- Becoming a team player
- Improving both verbal & nonverbal communication skills from placement perspective.
- Developing creative thought process and promoting innovative ideas.

### TRAINER DETAILS

Day	Date	Trainer Name
Day 1	11-Oct-22	Rumani, Anand, Aftab, Kavitha, Poonam, Anuradha
Day 2	12-Oct-22	Rumani, Chaitra, Aftab, Kavitha, Poonam, Anuradha
Day 3	13-Oct-22	Rumani, Anand, Nishida, Kavitha, Poonam, Anuradha
Day 4	14-Oct-22	Chaitra, Anand, Aftab, Nishida, Kavitha, Poonam, Nishida
Day 5	15-Oct-22	Chaitra, Anand, Aftab, Nishida, Kavitha, Poonam, Nishida

### MODULES COVERED

Day	Date	Module Covered
Day 1	11-Oct-22	Professional Etiquettes & Self Management
Day 2	12-Oct-22	Public Speaking & Team Building
Day 3	13-Oct-22	Formal Writing & Creative Thinking
Day 4	14-Oct-22	Business Language & Emotional Intelligence
Day 5	15-Oct-22	Presentation Skills







43	1KS21CS045	KANISHK E R	1	2	3	4	5	A	A	A	A	A	A	A	A	A	5	
44	1KS21CS046	KARTHIK H N	A	1	2	3	4	5	6	7	8	9	10	11	12	13	14	15
45	1KS21CS047	KAUSHIK G V	1	2	3	4	A	5	6	7	8	A	A	A	9	10	A	13
46	1KS21CS048	KAVANA N	1	2	3	4	5	6	7	8	9	10	11	12	13	14	15	15
47	1KS21CS049	KAVYA B SINGH	A	A	A	A	A	A	A	A	A	A	A	A	A	A	A	3
48	1KS21CS050	KEERTHIKA S	1	2	3	4	5	6	7	8	9	10	A	11	12	13	14	14
49	1KS21CS051	KONGARA SREE SAI	A	A	A	1	A	2	3	4	5	6	7	A	8	9	10	10
50	1KS21CS052	KUNAPALLI LAASYASHRRE	1	2	3	4	5	6	7	8	9	10	11	12	13	14	15	16
51	1KS21CS053	L.LAVANYA	1	2	3	A	A	A	A	A	A	A	A	A	A	A	A	13
52	1KS21CS054	M VAIBHAV NAYAK	1	2	A	3	A	A	4	5	A	6	7	A	A	A	A	7
53	1KS21CS055	MADHU SNEHA SHREE S	1	2	3	4	5	6	7	8	9	10	11	12	13	14	15	15
54	1KS21CS056	MANIKANTH	A	1	2	3	A	4	5	6	7	A	A	A	8	9	10	10
55	1KS21CS057	MANJUNATH	A	1	2	3	A	4	5	6	7	8	A	A	9	10	11	11
56	1KS21CS058	MANOJ KUMAR S	A	A	A	A	A	A	A	A	A	A	A	A	A	A	A	A
57	1KS21CS059	MAUSAM KUMAR	1	2	3	A	A	A	A	A	A	A	A	A	A	A	A	A
58	1KS21CS060	MAYA	1	2	3	4	A	A	5	6	7	8	9	10	11	12	13	13
No. of Students Absent			12	9	11	16	32	28	11	11	14	13	25	39	27	29	32	13
No. of Students Present			46	49	47	42	36	30	49	49	46	45	33	19	27	29	26	3
Signature of trainer/placement coordinator																		







**K.S INSTITUTE OF TECHNOLOGY**  
**CONSOLIDATED ATTENDANCE FOR INTERNSHIP PROGRAM**  
**COMPUTER SCIENCE AND ENGINEERING - OB 008**

II YEAR			III SEMESTER							BATCH 2								
S. No	USN	NAME OF THE STUDENT	Dates															TOTAL
			11/10/2022			12/10/2022			13/10/2022			14/10/2022			15/10/2022			
			1	2	3	4	5	6	7	8	9	10	11	12	13	14	15	
1	1KS21CS061	MONIKA D	1	2	3	4	5	6	7	8	9	10	11	12	13	14	15	15
2	1KS21CS062	N VIDYASAGAR	1	2	3	4	5	6	7	A	A	8	A	A	9	A	A	09
3	1KS21CS063	NAGADARSHAN R P	1	2	3	4	5	6	7	8	9	10	11	12	13	14	15	15
4	1KS21CS064	NAGASHREE A	1	2	3	A	A	A	4	5	6	7	8	9	10	11	A	11
5	1KS21CS065	NAREN RAKSHITH K V	1	A	A	2	3	A	A	A	4	5	A	A	A	A	A	5
6	1KS21CS066	NETYAM SHIVSARAN	1	2	3	4	5	6	7	8	9	10	11	12	13	14	A	14
7	1KS21CS067	NIKHIL SAI K V	A	A	A	A	A	A	A	A	A	A	A	A	A	A	A	00
8	1KS21CS068	NOOR ZAHIDA	1	2	3	4	5	6	7	8	9	10	11	A	A	A	A	12
9	1KS21CS069	OMKAR ARJUN MAGADUM	A	A	A	A	A	A	A	A	A	A	A	A	A	A	A	A
	1KS21CS070	POOJA G	1	2	3	4	5	6	7	8	9	10	11	12	13	14	A	14
11	1KS21CS071	POOJITHA M V	1	2	3	4	5	6	7	8	A	9	10	11	12	13	A	13
12	1KS21CS072	POOJITHA R	1	2	3	4	5	6	7	8	9	A	A	A	A	10	11	11
13	1KS21CS073	PRANAY G	A	A	A	A	A	A	A	A	A	A	A	A	A	A	A	0
14	1KS21CS074	PRIYANKA V	1	2	3	4	5	6	7	8	9	10	11	12	13	14	15	15
15	1KS21CS075	R AISHWARYA	1	2	3	4	A	A	5	6	7	8	9	10	11	12	13	13
16	1KS21CS076	R HARSHA	1	A	2	3	4	5	6	A	A	A	A	A	A	A	A	8
17	1KS21CS077	RAKSHITA G SATARADDI	1	2	3	4	5	6	7	8	9	10	11	12	13	14	A	14
18	1KS21CS078	RAKSHITHA D H	1	2	3	4	5	6	7	8	9	10	11	12	13	14	A	14
19	1KS21CS079	RASHMI B PHULARI	1	2	3	4	5	6	7	8	9	10	11	12	13	14	15	15
20	1KS21CS080	RAVEESH PRASAD M	1	2	3	4	5	6	7	8	9	10	11	12	13	14	15	15
21	1KS21CS081	RAVITEJ ARJUN KAKHANDAKI	A	A	A	A	A	A	A	A	A	A	A	A	A	A	A	00
22	1KS21CS082	REDDY TEJASWINI A	1	2	3	4	5	6	7	8	9	10	11	12	13	14	15	15
23	1KS21CS083	RUSHIKESH B	1	2	3	4	5	6	7	8	9	10	11	12	13	14	A	14
24	1KS21CS084	RUTHU M R	1	2	3	4	5	6	7	8	9	10	11	12	13	14	A	14
25	1KS21CS085	SAGAR S N	1	A	2	3	4	5	6	A	A	A	A	A	A	A	A	06
	1KS21CS086	SAMRAT SINGH	A	A	A	A	A	A	A	A	A	A	A	A	A	A	A	00
27	1KS21CS087	SANTHOSH K A	1	2	3	4	5	6	7	8	9	10	11	12	13	14	15	15
28	1KS21CS088	SHAMITHA RAVISHANKAR	1	2	3	4	5	6	7	8	9	10	11	12	13	14	A	14
29	1KS21CS089	SHEETAL NAIK	1	2	3	4	5	6	7	8	9	10	11	12	13	14	15	15
30	1KS21CS090	SHEETHAL G	1	2	3	A	4	5	6	7	8	9	10	11	12	13	14	14
31	1KS21CS091	SHEETHAL R	1	2	3	4	5	6	7	8	9	10	11	12	13	14	A	14
32	1KS21CS092	SHOEB AHMED QUADRI	A	A	A	A	A	A	A	A	A	A	A	A	A	A	A	00
33	1KS21CS093	SHREYAS C	A	A	A	A	A	A	A	A	A	A	A	A	A	A	A	00
34	1KS21CS094	SINDHU MEGHA	1	2	3	4	5	6	7	8	9	10	11	12	13	14	15	15
35	1KS21CS095	SKANDA KUMAR H S	1	2	3	4	5	6	7	8	9	10	11	12	13	14	15	15
36	1KS21CS096	SNEHA S	1	2	3	4	5	6	7	8	9	10	11	12	13	14	15	15
37	1KS21CS097	SOUJANYA N	1	2	3	4	5	6	7	8	9	10	11	12	13	14	15	15
38	1KS21CS098	SRINIDHI MADHUSUDHAN	1	2	3	A	A	A	4	A	A	5	6	7	8	9	10	10
39	1KS21CS099	SUMAN B S	1	2	3	4	5	6	7	8	9	10	11	12	13	14	15	15
40	1KS21CS100	SUMEDHA R	1	2	3	4	5	6	7	8	9	10	11	12	A	A	A	12
41	1KS21CS101	SUMUKHA S BHARADWAJ	1	2	3	4	5	6	7	8	9	10	11	12	13	14	15	15
42	1KS21CS102	SUNIDHI P	1	2	3	4	5	6	7	8	9	10	11	12	13	14	15	15
43	1KS21CS103	SURESH C	1	2	3	4	5	6	7	8	9	10	11	12	13	14	A	14
44	1KS21CS104	SUSHMITHA M	1	2	3	4	5	6	7	8	9	A	A	A	10	11	A	11



45	1KS21CS105	SWAROOP S KOWSHIK	1	2	3	4	5	6	7	8	9	10	11	12	13	14	15	15
46	1KS21CS106	TEJASHREE GOWDA Y K	1	2	3	4	5	6	7	8	9	10	11	12	13	14	15	15
47	1KS21CS107	UJWAL M L	1	2	3	4	5	6	7	8	9	10	11	12	13	14	15	15
48	1KS21CS108	V M TEJUS	1	2	3	4	A	A	5	6	7	8	9	10	11	12	13	13
49	1KS21CS109	VAISHALI BHOSLE	1	2	3	A	A	A	4	5	6	7	8	9	10	11	12	12
50	1KS21CS110	VANISHREE	1	2	3	4	5	6	7	8	9	10	11	12	13	14	A	14
51	1KS21CS111	VARSHA H R	1	2	3	4	5	6	7	8	9	10	11	12	13	14	15	15
52	1KS21CS112	VARUN SAI V	1	2	3	4	5	6	7	8	9	10	11	12	13	14	15	15
53	1KS21CS113	VIBHA GOVIN S	A	A	A	A	5	6	7	8	9	10	11	12	13	14	15	15
54	1KS21CS114	VIJETHA S	1	2	3	4	5	6	7	8	9	10	11	12	13	14	15	15
55	1KS21CS115	VILAS V	1	2	3	4	5	6	7	8	9	10	11	12	A	A	A	12
56	1KS21CS116	VISHAL KAMAN	1	2	3	4	5	6	7	8	9	10	11	12	13	14	15	15
57	1KS21CS117	YASHAS D GOWDA	1	2	3	4	5	6	7	8	9	10	11	12	13	14	15	15
58	1KS21CS118	YASHASHWINI R	1	2	3	4	5	6	7	8	9	10	11	12	13	14	15	15
No. of Students Absent			7	11	9	12	10	13	6	13	11	10	10	14	14	28		
No. of Students Present			51	47	49	46	48	45	52	46	45	47	47	44	44	30		
Signature of trainer/placement coordinator			<i>[Signature]</i>	<i>[Signature]</i>	<i>[Signature]</i>	<i>[Signature]</i>	<i>[Signature]</i>	<i>[Signature]</i>	<i>[Signature]</i>	<i>[Signature]</i>	<i>[Signature]</i>	<i>[Signature]</i>	<i>[Signature]</i>	<i>[Signature]</i>	<i>[Signature]</i>	<i>[Signature]</i>	<i>[Signature]</i>	<i>[Signature]</i>







# K.S INSTITUTE OF TECHNOLOGY

## CONSOLIDATED ATTENDANCE FOR INTERNSHIP PROGRAM

### ELECTRONICS AND COMMUNICATION ENGINEERING - OB 101

Morning - 9:30 a.m  
 - 11:30 a.m  
 - 2:15 p.m

II YEAR			III SEMESTER									BATCH 3									
S. No	USN	NAME OF THE STUDENT	Dates															TOTAL			
			11/10/2022			12/10/2022			13/10/2022			14/10/2022			15/10/2022						
			1	2	3	4	5	6	7	8	9	10	11	12	13	14	15				
1	1KS21EC001	AADHYA B N	✓	2	3	4	A	A	5	6	7	8	9	10	11	12	13	14	15	13	
2	1KS21EC002	ABHIJITH R	✓	2	3	4	5	6	7	8	9	10	11	12	13	14	15				15
3	1KS21EC003	ABHISHEK H C	✓	2	3	4	A	A	5	6	7	A	8	9	10	A	A				10
4	1KS21EC004	ABHISHEK T S	✓	2	3	4	5	6	7	8	9	10	11	12	13	14	15				15
5	1KS21EC005	AISHWARYA A	✓	2	3	4	5	6	A	A	A	7	8	9	10	11	12				12
6	1KS21EC006	AKSHAY C	✓	2	3	4	5	6	A	A	A	7	8	9	10	11	12				08
7	1KS21EC007	AKSHAY M S	✓	2	3	A	4	5	6	7	A	8	A	A	A	8	A	A			08
8	1KS21EC008	ANAGHA PRAKASH	✓	2	3	4	A	A	5	6	7	A	A	A	8	A	A				08
9	1KS21EC009	ANIRUDHA R BHAT	✓	2	3	4	A	A	5	6	7	A	A	A	8	A	A				08
10	1KS21EC010	ARCHANA G M	✓	2	3	4	A	A	5	6	7	A	A	A	8	A	A				08
11	1KS21EC011	ARCHANA M	✓	2	3	4	A	A	5	6	7	8	9	10	8	A	A				11
12	1KS21EC012	ARJUN BHARADWAJ	✓	2	3	4	5	6	7	8	9	10	11	8	9	10					15
13	1KS21EC013	ASHCHARYA N B	✓	2	3	4	A	A	5	6	7	8	9	10	11	12	9	10	11		15
14	1KS21EC014	ASHWIN S R	✓	2	3	4	A	A	5	6	7	8	9	10	7	A	A				11
15	1KS21EC015	B N JEEVAN	A	1	2	3	4	5	6	7	8	9	10	11	8	A	A				07
16	1KS21EC016	B P SAMARTH	✓	A	A	A	A	A	A	A	A	A	A	A	A	A	A				12
17	1KS21EC017	B S BHARGAV	A	A	A	A	A	A	A	A	A	A	A	A	A	A	A				01
18	1KS21EC018	BHAVYA K	✓	2	3	A	4	5	6	7	8	9	10	11	12	13	14			(A)	14
19	1KS21EC019	BHUVANA H	A	A	A	1	2	3	4	5	6	7	8	9	10	11	12				12
20	1KS21EC020	BINDUSHREE S	✓	2	3	4	5	6	7	8	9	A	10	11	12	A	A				12
21	1KS21EC021	CHINTAN D S	✓	2	3	4	5	6	7	8	9	10	11	12	13	14	15				15
22	1KS21EC022	CHIRAG S	✓	A	A	A	2	3	A	A	A	4	5	A	A	A	A				05
23	1KS21EC023	CHIRANTH V V	✓	2	3	4	5	6	7	8	9	10	11	12	13	14	15				15
24	1KS21EC024	DAGGUPATI CHARITHA	A	A	A	A	A	1	2	A	3	A	A	A	A	A	A				03
25	1KS21EC025	DAMINI S	A	A	A	1	A	A	2	3	A	4	A	A	A	A	A				04
26	1KS21EC026	DEEKSHA H K	✓	2	3	4	A	A	5	6	7	A	A	A	8	A	A				08
27	1KS21EC027	DEEPIKA D	✓	2	3	4	A	A	5	6	A	7	8	9	A	A	A				09
28	1KS21EC028	GAGAN V	A	1	2	3	4	5	4	5	6	7	8	9	10	A	A				10
29	1KS21EC029	GAGANA SINDHU N	✓	2	3	4	5	6	7	8	9	10	11	12	13	A	A				13
30	1KS21EC030	GREESHMA S	A	A	A	A	A	A	A	A	A	A	A	A	A	A	A				(A)
31	1KS21EC031	GURUSHANKARA M	✓	2	3	4	A	A	5	6	7	8	9	10	11	A	A				11
32	1KS21EC032	HARINI.L	✓	A	A	2	2	A	5	6	7	8	A	A	9	A	A				09
33	1KS21EC033	HEMANTH D R	✓	2	3	4	5	6	7	8	9	A	10	11	12	A	A				12
34	1KS21EC035	KAMBHAMPATI VIVEK	A	A	A	A	A	A	A	A	A	A	A	A	A	A	A				(A)
35	1KS21EC036	KARAN S	✓	2	3	4	5	6	7	8	9	10	11	12	13	14	15				15
36	1KS21EC037	KEERTHANA S	✓	2	3	4	A	A	5	6	7	A	A	A	8	A	A				08
37	1KS21EC038	KOMALA N	A	A	A	1	2	3	4	5	6	7	A	A	A	A	A				07
38	1KS21EC039	KUSHAL GOWDA U	✓	A	A	A	2	3	A	A	A	4	A	A	5	A	A				05
39	1KS21EC040	KUSUMA M S	A	1	A	2	3	4	5	6	7	8	9	10	A	A	A				10
40	1KS21EC041	LIKITHA L	✓	2	3	4	5	6	7	8	9	10	11	12	13	A	A				13
41	1KS21EC042	LOHIT HOOLAGERI	✓	A	A	2	2	A	5	6	7	8	9	10	11	A	A				11
42	1KS21EC043	LOHITH B	A	A	A	A	A	A	A	A	A	A	A	A	A	A	A				(A)
43	1KS21EC044	LOHITH S	A	A	A	1	2	3	A	A	4	5	A	A	6	A	A				06
44	1KS21EC045	MANOJ T V	A	A	A	A	1	2	3	4	5	A	A	A	6	A	A				06







9:15 a.m  
11:30 a.m  
2:15 p.m.



**K.S INSTITUTE OF TECHNOLOGY**  
**CONSOLIDATED ATTENDANCE FOR INTERNSHIP PROGRAM**  
**ELECTRONICS & COMMUNICATION ENGINEERING - OB 203**

II YEAR			III SEMESTER									BATCH 4						
S. No	USN	NAME OF THE STUDENT	Dates															TOTAL
			11/10/2022			12/10/2022			13/10/2022			14/10/2022			15/10/2022			
			1	2	3	4	5	6	7	8	9	10	11	12	13	14	15	
1	1KS21EC061	POOJA R	1	2	A	3	4	5	A	A	A	A	A	A	A	A	A	05
2	1KS21EC062	PRAJWAL D	A	A	A	A	A	A	A	A	A	A	A	A	A	A	A	(A)
3	1KS21EC063	PRAJWAL G V	A	1	2	A	3	4	5	6	7	8	9	10	A	A	A	10
4	1KS21EC064	PRAJWAL H S	A	A	A	A	A	A	A	A	A	A	A	A	A	A	A	(A)
5	1KS21EC065	PRAJWAL R	A	A	1	2	3	4	5	6	7	8	A	A	A	A	A	08
6	1KS21EC066	PRATHAM R SHANBHAG	1	2	A	A	A	A	A	A	A	A	A	A	A	A	A	02
7	1KS21EC067	PRAYAG SINGH S	A	1	A	A	2	3	A	5	6	7	A	A	A	A	A	07
8	1KS21EC068	PREETHAM M	A	1	A	A	A	A	3	4	A	5	A	A	A	A	A	05
9	1KS21EC069	PREKSHA S	1	2	3	4	5	6	7	8	9	10	A	A	A	A	A	10
10	1KS21EC070	PUNITH M	A	1	2	3	4	A	5	6	7	A	A	A	8	9	A	09
11	1KS21EC071	RAGHAVENDRA NARAYAN PUJAR	1	A	A	A	A	A	A	A	A	A	A	A	A	A	A	01
12	1KS21EC072	RAKSHITH S	1	2	3	A	5	6	7	8	9	10	11	12	A	A	A	12
13	1KS21EC073	RAKSHITHA M R	1	2	A	A	3	4	5	6	A	7	A	A	A	A	A	07
14	1KS21EC074	RAYADURG JOISH SHRIYA	1	2	3	A	A	A	4	5	A	6	A	A	A	A	A	06
15	1KS21EC075	REHAMAN SHARIFF	A	1	2	3	A	5	6	7	8	A	A	A	9	10	A	10
16	1KS21EC076	RITESH KUMAR SINHA	A	1	A	A	A	A	2	3	A	4	A	A	A	A	A	04
17	1KS21EC077	RITHIKA M	1	2	A	A	A	A	A	A	A	A	A	A	A	A	A	02
18	1KS21EC078	S HARI DHANUSH	A	A	A	A	A	A	A	A	A	A	A	A	A	A	A	(A)
19	1KS21EC080	S. SHAJITH ALI	1	2	A	A	A	A	A	A	A	A	A	A	A	A	A	02
20	1KS21EC081	SAGAR G S	A	1	2	A	3	4	5	6	7	8	9	A	A	A	A	09
21	1KS21EC082	SAI RAHUL N	A	1	A	2	3	4	5	A	A	6	A	A	A	A	A	06
22	1KS21EC083	SAMHITHA PRAKASH	A	A	A	A	A	A	A	A	A	A	A	A	A	A	A	(A)
23	1KS21EC084	SANJANA V	1	2	3	4	5	6	7	8	9	10	A	A	A	A	A	10
24	1KS21EC085	SANJAY G	A	A	A	1	2	3	4	A	5	6	7	8	A	A	A	08
25	1KS21EC086	SANJAY N	A	A	A	1	2	A	A	3	A	A	A	A	A	A	A	03
26	1KS21EC087	SANJAY P	1	2	3	4	5	6	7	8	9	10	A	A	A	A	A	10
27	1KS21EC088	SATHYAM KUMAR MANDAL S	A	A	A	A	A	A	A	A	A	A	A	A	A	A	A	(A)
28	1KS21EC089	SHAIK ARFATH	1	2	3	4	5	6	7	8	9	10	A	11	12	13	A	13
29	1KS21EC090	SHASHANK C U	1	2	3	4	5	A	6	7	8	9	A	A	10	11	A	11
30	1KS21EC091	SHREYAS RAGHAVENDRA V	1	2	A	A	A	A	A	A	A	A	A	A	A	A	A	02
31	1KS21EC092	SHWETHA V	A	1	2	3	4	5	6	7	8	A	A	A	A	A	A	07
32	1KS21EC093	SINDHU M NIMBAL	A	A	A	1	2	A	A	A	A	A	A	A	A	A	A	02
33	1KS21EC095	SPOORTHY M U	1	2	3	4	5	6	7	8	9	10	A	A	A	A	A	10
34	1KS21EC096	SRILAKSHMI G	A	A	A	A	A	A	A	A	A	A	A	A	A	A	A	(A)
35	1KS21EC097	SRIPRIYA H G	A	1	A	A	A	A	A	A	A	A	A	A	A	A	A	01
36	1KS21EC098	SUMUKH P	A	A	A	A	A	A	A	A	A	A	A	A	A	A	A	(A)
37	1KS21EC099	SUNEETHA	A	A	A	A	A	A	A	A	A	A	A	A	A	A	A	(A)
38	1KS21EC100	SUNEHA S	1	2	3	4	5	6	7	8	9	10	11	12	13	A	A	13
39	1KS21EC101	SUPREETH A	1	2	3	4	5	6	7	8	9	10	11	12	A	A	A	12
40	1KS21EC102	SURABHI K R	1	2	3	4	5	6	7	8	9	10	11	12	A	A	A	12
41	1KS21EC103	SUSHEN KRISHNAPUR	1	2	3	4	5	6	7	8	9	10	11	12	A	A	A	12
42	1KS21EC104	TARUN M	A	A	A	A	1	2	A	3	4	A	A	A	A	A	A	04
43	1KS21EC105	TEJASHREE N	A	A	A	A	A	A	A	A	A	A	A	A	A	A	A	(A)
44	1KS21EC106	THARUN K V	A	1	2	3	4	5	6	7	8	9	A	A	A	A	A	03



45	1KS21EC107	THEJAS H V	A	1	A	A	A	2	3	A	4	A	A	A	A	A	04	
46	1KS21EC108	THUSHAR CHERIAN	A	1	A	A	2	3	A	4	5	A	A	A	A	A	05	
47	1KS21EC109	UDAYA KUMAR S R	A	A	A	A	A	A	A	A	A	A	A	A	A	A	05	
48	1KS21EC110	VAISHNAVI B A	A	A	A	A	A	A	A	A	A	A	A	A	A	A	(A)	
49	1KS21EC111	VARSHA JAYAKUMAR	A	1	2	3	4	5	6	7	8	9	10	11	A	A	A	(A)
50	1KS21EC112	VARSHA S DAVASKAR	A	A	A	A	A	A	A	A	A	A	A	A	A	A	(A)	
51	1KS21EC113	VARSHITH S	A	A	A	A	A	A	1	A	2	A	A	A	A	A	02	
52	1KS21EC114	VEERESH K N	A	A	A	A	1	A	A	A	A	A	A	A	A	A	01	
53	1KS21EC115	VIDYA I	A	1	2	A	3	4	A	5	6	A	A	A	A	A	06	
54	1KS21EC116	VIDYA RAWAL D	A	1	2	3	4	5	6	7	8	9	A	A	A	A	09	
55	1KS21EC117	VIDYASHREE R	A	2	A	A	A	A	A	A	A	A	A	A	A	A	02	
56	1KS21EC118	VIJAY YADAV R	A	1	A	A	A	A	2	3	A	A	A	A	A	A	03	
57	1KS21EC120	VYSHAK G R	A	A	A	A	A	A	A	A	A	A	A	A	A	A	(A)	
58	1KS21EC121	YASHWANTH.M	A	1	A	A	A	A	A	A	A	A	A	A	A	A	01	
No. of Students Absent			37	21	35	35	26	32	29	26	34	31	29	69	53	54	58	
No. of Students Present			21	37	23	23	32	26	29	32	24	27	9	9	5	4	00	
Signature of trainer/placement coordinator																		



9) Rumani Bhandari.

10) Poonam Brijaj

11)

12)



9:15 a.m  
11:30 a.m  
2:15 p.m



**K.S INSTITUTE OF TECHNOLOGY**  
**CONSOLIDATED ATTENDANCE FOR INTERNSHIP PROGRAM**  
**COMPUTER SCIENCE AND DESIGN - OB 105**

II YEAR			III SEMESTER						BATCH 5									
S. No	USN	NAME OF THE STUDENT	Dates															TOTAL
			11/10/2022			12/10/2022			13/10/2022			14/10/2022			15/10/2022			
			1	2	3	4	5	6	7	8	9	10	11	12	13	14	15	
1	1KS21CG001	A S N SREEYA	1	2	3	4	5	6	7	8	9	10	11	12	13	14	15	15
2	1KS21CG002	ABDUS SALAAM I	1	2	2	2	2	2	2	2	2	2	2	2	2	2	2	02
3	1KS21CG003	ABHILASHA PATIL	1	2	3	4	5	6	7	8	9	10	11	12	13	14	15	15
4	1KS21CG004	ANAGHA SHASTRY	1	2	3	4	5	6	7	8	9	10	11	12	13	14	15	15
5	1KS21CG005	ANKITHA DEVLOKAM	1	2	3	4	5	6	7	8	9	10	11	12	13	14	15	15
6	1KS21CG006	ARPITHA G R	1	2	3	4	5	6	7	8	9	10	11	12	13	14	15	15
7	1KS21CG007	B H RUCHIRA	1	2	3	4	5	6	7	8	9	10	11	12	12	12	12	12
8	1KS21CG008	BADARI PRASAD M	1	2	3	4	5	6	7	8	9	10	11	12	13	14	15	15
9	1KS21CG009	BHARAT R	A	A	A	A	A	A	A	A	A	A	A	A	A	A	A	A
10	1KS21CG010	BUDEN GOUDA	A	A	A	A	A	A	2	3	3	3	3	3	3	3	3	10
11	1KS21CG011	CHALLA DEEPIKA	1	2	3	4	5	6	7	8	9	10	11	12	13	14	15	15
12	1KS21CG012	DANDA AJITH KUMAR	1	A	A	A	A	A	2	3	4	5	6	7	8	9	10	10
13	1KS21CG013	DEEPIKA S	1	2	3	4	5	6	7	8	9	10	11	12	13	14	15	15
14	1KS21CG014	DEEPTHI G B	1	2	3	4	5	6	7	8	9	10	11	12	13	14	15	15
15	1KS21CG015	DHANUSH B K	1	2	3	4	5	6	7	8	9	10	11	12	13	14	15	15
16	1KS21CG016	DIVYA T	1	2	3	4	5	6	7	8	9	10	11	12	13	14	15	15
17	1KS21CG017	G PRADEEP	1	2	3	4	4	5	6	7	8	10	10	11	12	12	12	12
18	1KS21CG018	G YOGIRAM	1	2	3	A	4	5	6	7	8	8	9	10	11	11	11	11
19	1KS21CG019	GOVIND VENKATESHA SHETTY	1	2	3	4	5	6	7	8	9	10	11	12	13	13	13	13
20	1KS21CG020	HEMANTH M	1	2	3	4	5	6	7	8	9	10	11	12	13	14	15	15
21	1KS21CG021	KARTHIK C S	1	2	3	4	5	6	7	8	9	10	11	12	13	13	13	13
22	1KS21CG022	KEERTHANA LOKESH	A	A	A	1	2	3	4	5	6	6	6	6	6	6	6	06
23	1KS21CG023	KEERTHANA S	1	2	3	3	3	3	3	3	3	4	5	6	7	8	9	09
24	1KS21CG024	KEERTHANA S D	1	2	3	4	5	6	6	6	6	7	8	9	10	10	10	10
25	1KS21CG025	KUSHAL M J	1	2	3	4	5	6	7	8	9	10	11	12	13	14	15	15
26	1KS21CG026	KUSUM PAKIRA	1	2	3	4	5	6	7	8	9	10	11	12	13	14	15	15
27	1KS21CG027	MONISHA M	1	2	3	4	5	6	7	8	9	10	11	12	13	14	15	15
28	1KS21CG028	NEHA M R	1	2	3	4	5	6	7	8	9	10	11	12	13	14	15	15
29	1KS21CG029	NISHANTH G K	1	2	3	4	5	6	7	8	9	10	11	12	13	14	15	15
30	1KS21CG030	PAVITHRAA G	1	2	3	4	5	6	7	8	9	10	11	12	13	14	15	15
31	1KS21CG031	PRATEEK C HIEMATH	1	2	3	4	5	6	7	8	9	10	9	9	9	9	9	9
32	1KS21CG032	PREETHAM H V	1	2	3	4	5	6	7	8	9	10	10	12	13	13	13	13
33	1KS21CG033	RAYALA SAI PRAKASH	1	2	3	4	5	6	7	8	9	10	11	12	13	14	15	15
34	1KS21CG034	RIYA NAIR	1	2	3	4	5	6	7	8	9	10	11	12	13	13	13	13
35	1KS21CG035	SANJANA SREENIVAS	1	2	3	4	5	6	7	8	9	10	11	12	13	13	13	13
36	1KS21CG036	SANJANA V	A	2	3	4	5	6	7	8	9	10	11	12	13	14	15	15
37	1KS21CG037	SANJAY P	M	2	3	4	5	6	7	8	9	10	11	12	13	13	13	13
38	1KS21CG038	SATHYA SAI SRI B S	1	2	3	4	5	6	7	8	9	10	11	12	13	14	15	15
39	1KS21CG039	SAVYASHREE S	1	2	3	4	5	6	7	8	9	10	11	12	13	13	13	13
40	1KS21CG040	SHALINI B	1	2	3	4	5	6	7	8	9	10	11	12	13	13	13	13
41	1KS21CG041	SHISHIRA MOHAN	1	2	3	4	5	6	7	8	8	9	10	10	11	11	11	11
42	1KS21CG042	SHIVANI ADHIKARI	1	2	3	4	5	6	7	8	9	10	11	12	13	14	15	15
43	1KS21CG043	SHREYAS G	1	2	3	4	5	6	7	8	9	10	11	12	13	13	13	13
44	1KS21CG044	SHREYAS M	1	2	3	4	5	6	7	8	9	10	11	12	13	13	13	13



			11/10	12/10	13/10	14/10	15/10
45	1KS21CG045	SHRUTHI K RAJ	1 2 3	4 5 6	7 8 9	10 11 12	13 13 13 13
46	1KS21CG046	SUDARSHAN BABU A	1 2 2 2	2 2 2	3 4 5	6 7 8	8 8 8 08
47	1KS21CG047	SUMANA R	1 2 3	4 5 6	7 8 9	10 11 12	13 14 15 15
48	1KS21CG048	SUMANTH V SHET	A A A	A A A	A A A	A A A	A A A (A)
49	1KS21CG049	TARUN JANGIR	1 2 3	4 5 6	7 8 9	10 11 12	13 13 13 13
50	1KS21CG050	THANUJA B	1 2 3	4 5 6	7 8 9	10 11 12	13 13 13 13
51	1KS21CG051	THEJAS B S	1 2 3	4 5 6	7 8 9	10 11 12	13 14 15 15
52	1KS21CG052	UNUGURU GIRI SANKAR	1 2 3	3 3 3	4 5 9	10 11 12	13 14 15 15
53	1KS21CG053	VAISHNAVI S	1 2 3	4 5 6	7 8 9	10 11 12	13 14 14 14
54	1KS21CG054	VARSHITHA S	1 2 3	4 5 6	7 8 9	10 11 12	13 14 15 15
55	1KS21CG055	VARSHITHA SRIDHAR	1 2 3	4 5 6	7 8 9	10 11 12	13 14 15 15
56	1KS21CG056	VIDHEESHA T M	1 2 3	4 5 6	7 8 9	10 11 12	13 14 15 15
57	1KS21CG057	VIGNESH U	1 2 3	4 5 6	7 8 9	10 11 12	13 13 13 13
58	1KS21CG058	VYSHNAVI S N	1 2 3	4 5 6	7 8 9	10 11 12	13 13 13 13
59	1KS21CG059	YEDDULAPALLI SAHITHI	1 2 3	3 3 3	4 5 9	10 11 12	12 12 12 12
No. of Students Absent			5 5 7	10 10 10	4 4 6	6 7 7	10 26 29
No. of Students Present			54 54 52	49 49 49	55 55 53	53 52 52	49 33 30
Signature of trainer/placement coordinator			R B R	R B R	R B R	R B R	R B R R

Rumani  
Anuradha,









50	1KS21AI050	SUHAS R	A	A	A	A	A	A	A	A	A	A	A	A	A	A	A	A	A
51	1KS21AI051	SURABHI T G	1	A	A	1	2	3	1	2	3	1	2	3	A	A	A	A	A
52	1KS21AI052	TANUSHREE S	1	2	3	1	2	3	1	2	3	1	2	3	A	A	A	A	A
53	1KS21AI053	THRYAKSHARI S	A	A	1	A	A	A	A	A	A	A	A	A	A	A	A	A	A
54	1KS21AI054	VARNIKA V N	1	2	3	1	2	3	1	2	3	1	2	3	1	2	3	1	2
55	1KS21AI055	VENKATESH T	1	2	A	1	2	3	1	2	3	1	2	3	1	2	3	1	2
56	1KS21AI056	VINITH P	1	2	3	A	A	A	A	A	A	1	2	3	1	2	3	1	2
57	1KS21AI057	ZUHA SUHAIL	1	2	3	A	A	A	A	A	A	1	2	3	1	2	3	1	2
58	1KS21ME001	A ASLAM BASHA	1	2	3	1	2	3	1	2	3	1	2	3	1	2	3	1	2
59	1KS21ME002	DHANUSH R	A	1	2	A	2	3	1	2	3	1	2	3	A	A	A	A	A
60	1KS21ME003	HEMANTH H	A	A	A	1	2	3	1	2	3	1	2	3	1	2	3	1	2
61	1KS21ME004	K HARISH KUMAR	A	1	A	A	2	3	1	2	3	1	2	3	A	A	A	A	A
62	1KS21ME005	MANOJ T S	A	A	A	1	2	3	1	2	3	1	2	3	1	2	3	1	2
63	1KS21ME006	N EKANTH	1	2	3	1	2	A	1	2	3	1	2	3	1	A	A	A	A
64	1KS21ME007	NITIN KUMAR P	A	A	A	A	A	A	A	A	A	A	A	A	A	A	A	A	A
65	1KS21ME008	PAVAN K	1	2	3	1	2	3	1	2	3	1	2	3	1	2	3	1	2
66	1KS21ME009	PAVANKUMAR H	1	2	A	1	2	3	1	2	3	A	A	A	1	A	A	A	A
67	1KS21ME010	RAJESH KUMAR N G	1	2	3	1	2	3	1	2	3	1	2	3	A	A	A	A	A
68	1KS21ME011	ROHIT KUMAR S	A	1	A	1	2	3	1	2	3	1	2	3	A	1	2	3	1
No. of Students Absent			15	14	18	12	12	13	10	10	10	10	10	10	25	25	25		
No. of Students Present			52	53	49	55	55	54	58	58	58	58	58	58	43	43	43		
Signature of trainer/placement coordinator			P	P	P	P	P	P	P	P	P	P	P	P	P	P	P	P	P

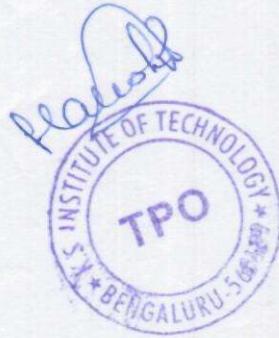



# Departments of Training and Placements

## Internship Program for 3<sup>rd</sup> Semester students\_2022-2023

### Glimpse of Activities conducted during internship program

Date: 11<sup>th</sup> – 15<sup>th</sup> October 2022



Batch 1: CSE – Session 2 (Day 1)



Batch 2: CSE – Session 3 (Day 2)



Batch 4: ECE – Session 1 (Day 3)



Batch 3: ECE – Session 3 (Day 4)



Batch 5: CSD – Session 3 (Day 5)



Batch 6: AIML & ME– Session 2 (Day 5)





# Feedback form\_INTERNSHIP\_3rd SEM\_Day 1\_11-10-2022

167 responses

[Publish analytics](#)

## Date

167 responses

Copy

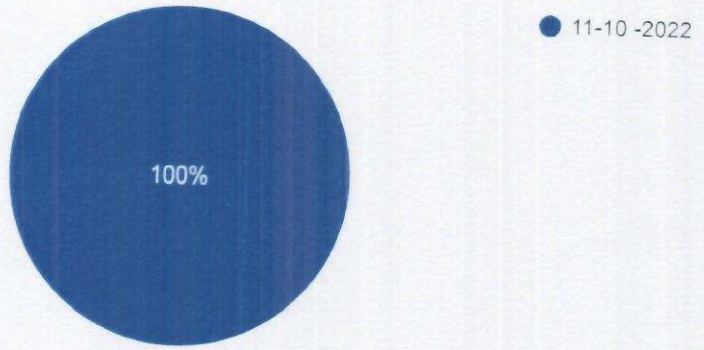

## Session

167 responses

Copy

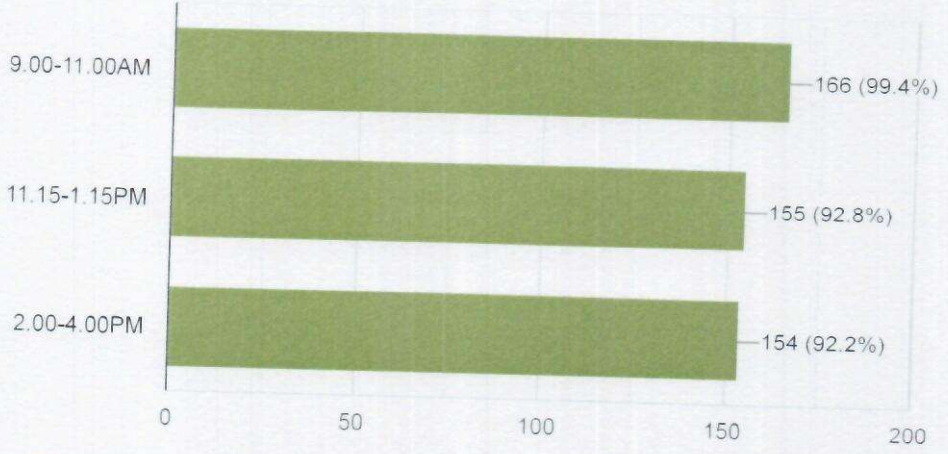



### TRAINER NAME

 Copy

167 responses

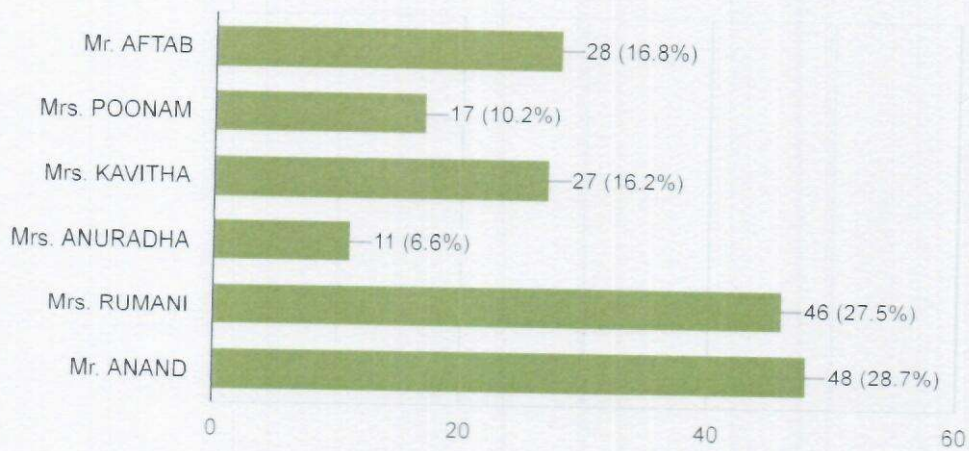

### TOPICS COVERED

 Copy

167 responses

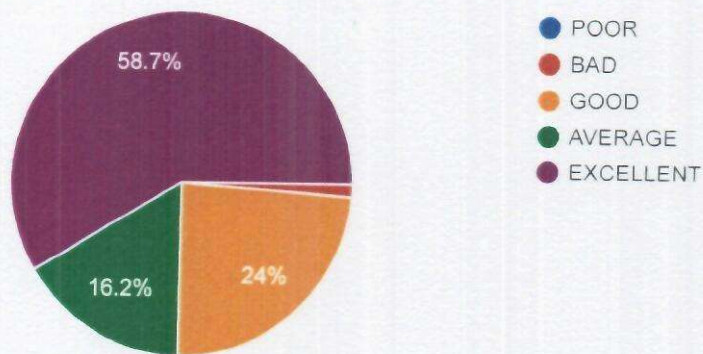

### CONCEPTUAL CLARITY/ SUBJECT KNOWLEDGE

 Copy

167 responses

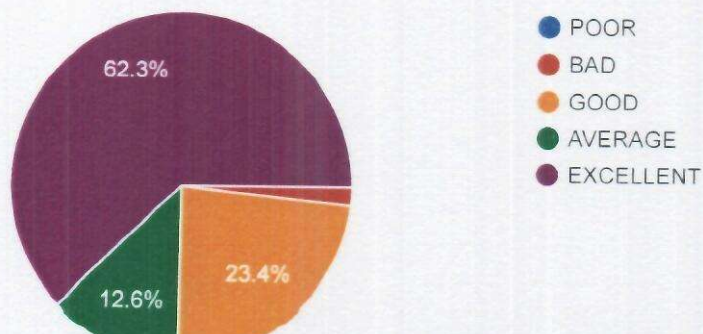



### SOLVING DOUBTS/ INTERACTION

 Copy

167 responses

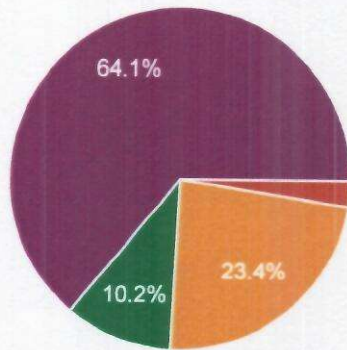

- POOR
- BAD
- GOOD
- AVERAGE
- EXCELLENT

### TIME MANAGEMENT

 Copy

167 responses

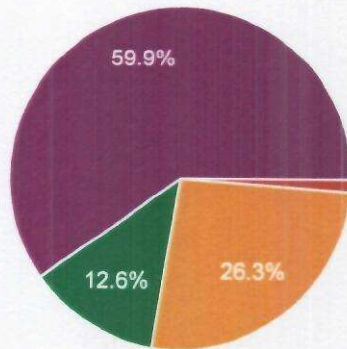

- POOR
- BAD
- GOOD
- AVERAGE
- EXCELLENT

### OVERALL RATING

 Copy

167 responses

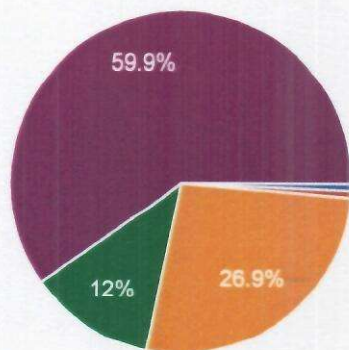

- POOR
- BAD
- GOOD
- AVERAGE
- EXCELLENT







# Feedback form\_INTERNSHIP\_3rd SEM\_Day 2\_12-10-2022

150 responses

[Publish analytics](#)

## Date

150 responses

 Copy

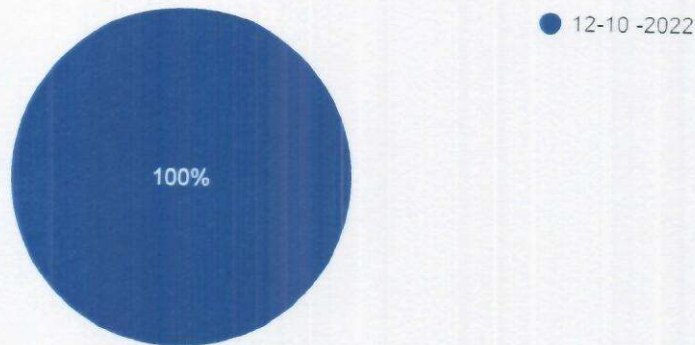

## Session

150 responses

 Copy

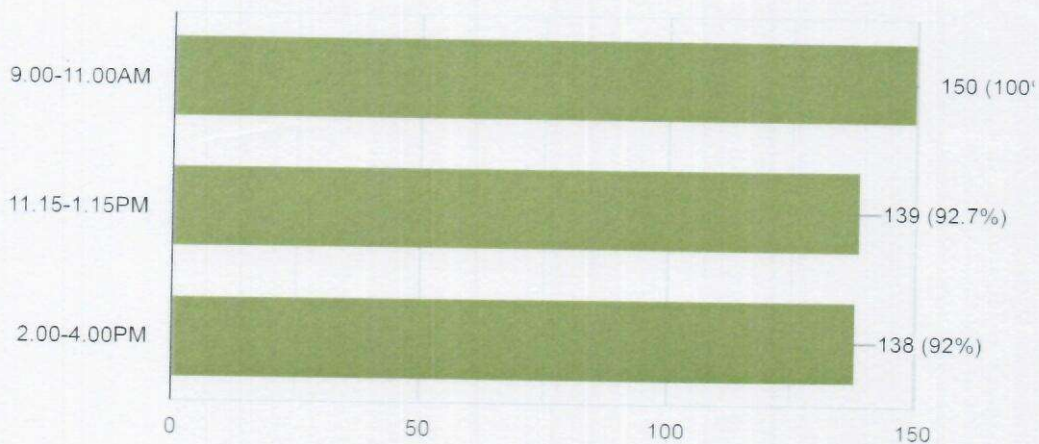



### TRAINER NAME

 Copy

150 responses

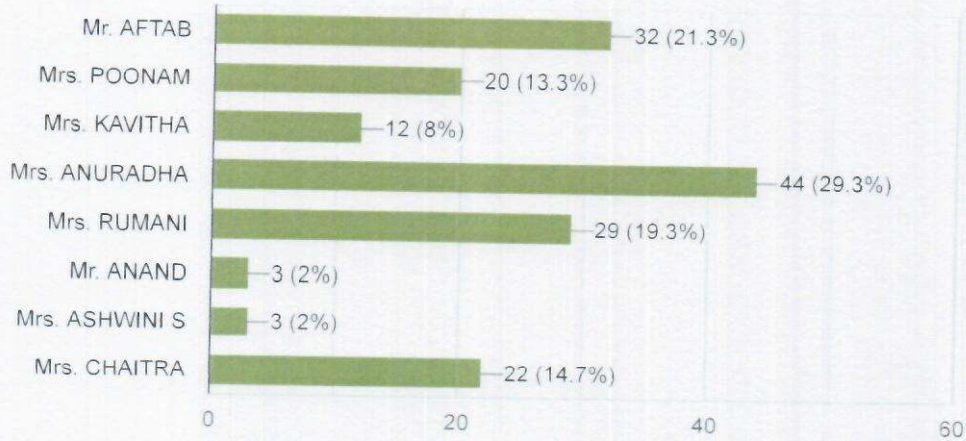

### TOPICS COVERED

 Copy

150 responses

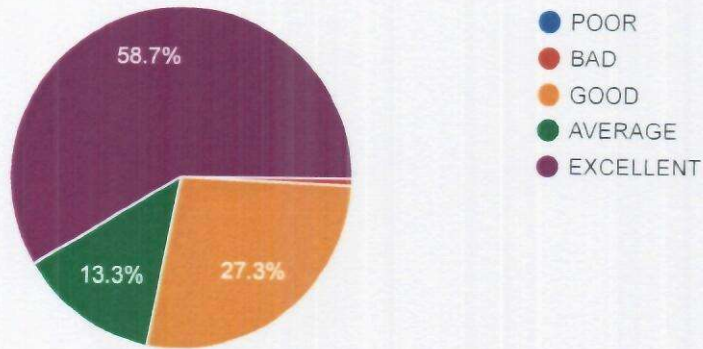

### CONCEPTUAL CLARITY/ SUBJECT KNOWLEDGE

 Copy

150 responses

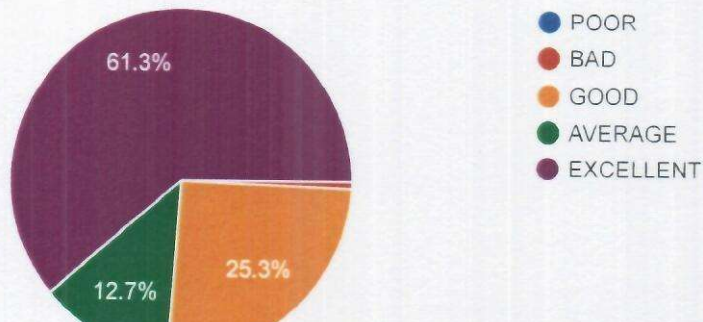



### SOLVING DOUBTS/ INTERACTION

 Copy

150 responses

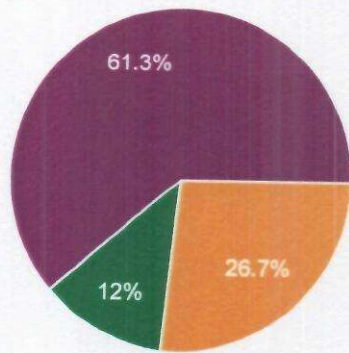

- POOR
- BAD
- GOOD
- AVERAGE
- EXCELLENT

### TIME MANAGEMENT

 Copy

150 responses

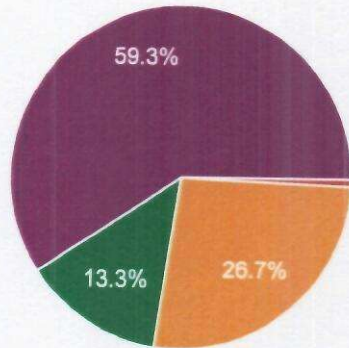

- POOR
- BAD
- GOOD
- AVERAGE
- EXCELLENT

### OVERALL RATING

 Copy

150 responses

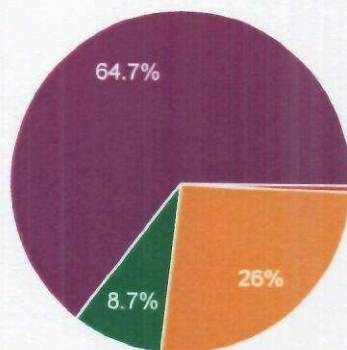

- POOR
- BAD
- GOOD
- AVERAGE
- EXCELLENT







# Feedback form\_INTERNSHIP\_3rd SEM\_Day 3\_13-10-2022

160 responses

[Publish analytics](#)

## Date

160 responses

Copy

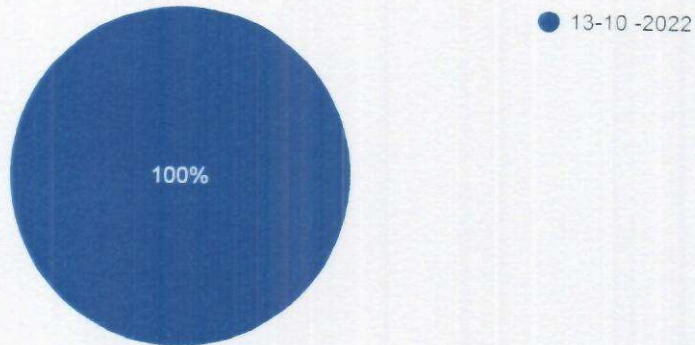

## Session

160 responses

Copy

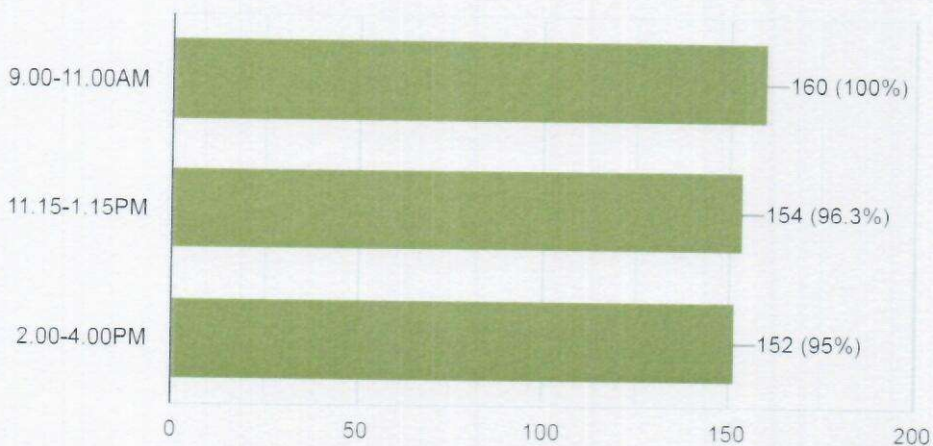



### TRAINER NAME

 Copy

160 responses

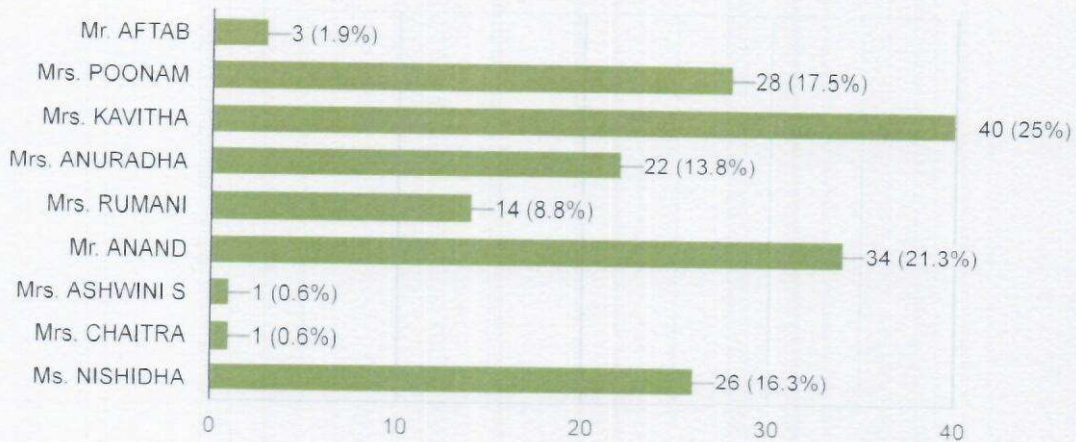

### TOPICS COVERED

 Copy

160 responses

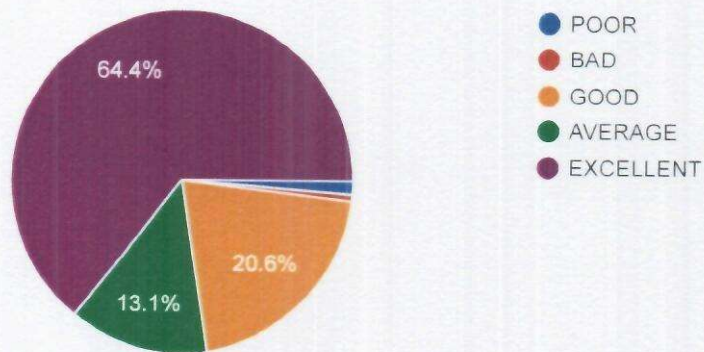

### CONCEPTUAL CLARITY/ SUBJECT KNOWLEDGE

 Copy

160 responses

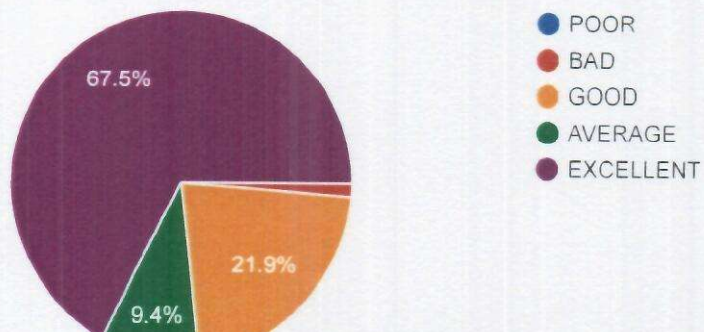



### SOLVING DOUBTS/ INTERACTION

 Copy

160 responses

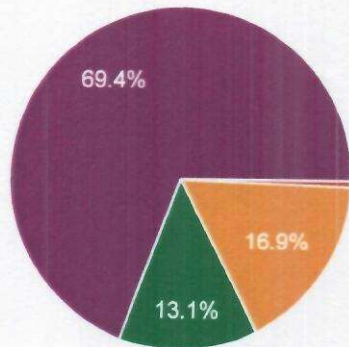

- POOR
- BAD
- GOOD
- AVERAGE
- EXCELLENT

### TIME MANAGEMENT

 Copy

160 responses

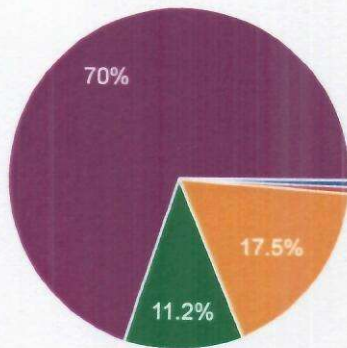

- POOR
- BAD
- GOOD
- AVERAGE
- EXCELLENT

### OVERALL RATING

 Copy

160 responses

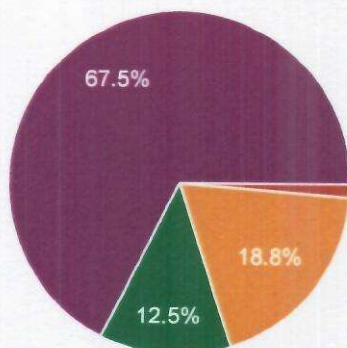

- POOR
- BAD
- GOOD
- AVERAGE
- EXCELLENT







# Feedback form\_INTERNSHIP\_3rd SEM\_Day 4\_14 - 10 - 2022

139 responses

[Publish analytics](#)

## Date

139 responses

Copy

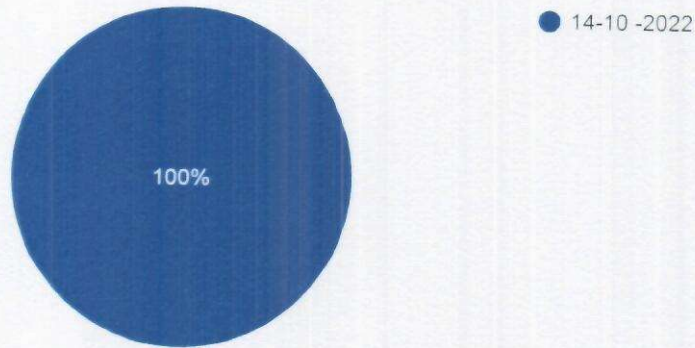

## Session

139 responses

Copy

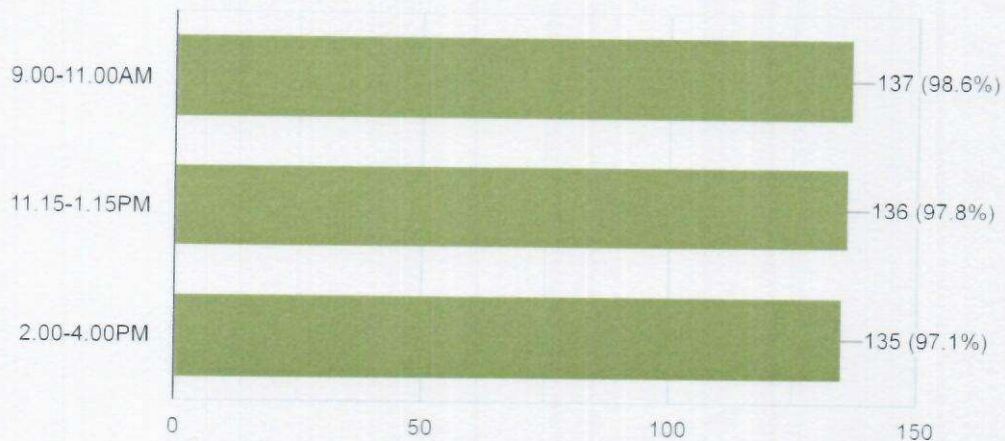



### TRAINER NAME

 Copy

139 responses

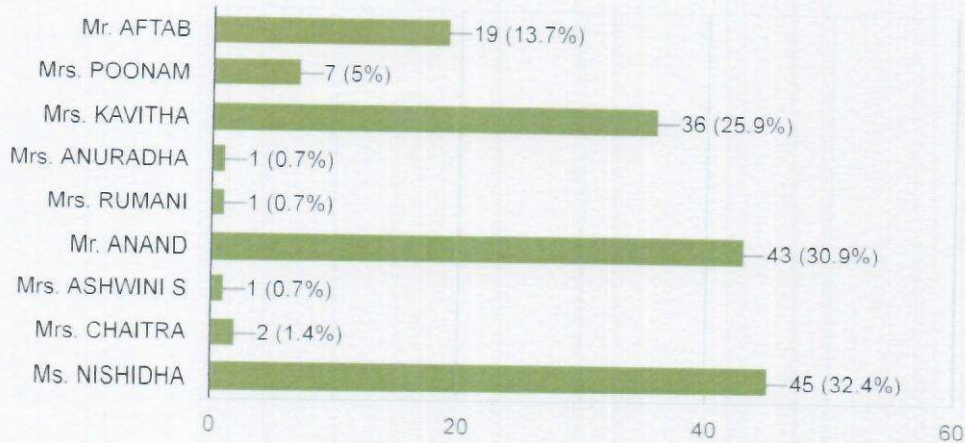

### TOPICS COVERED

 Copy

139 responses

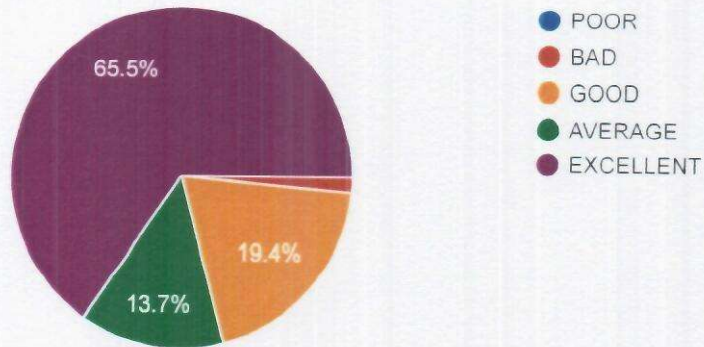

### CONCEPTUAL CLARITY/ SUBJECT KNOWLEDGE

 Copy

139 responses

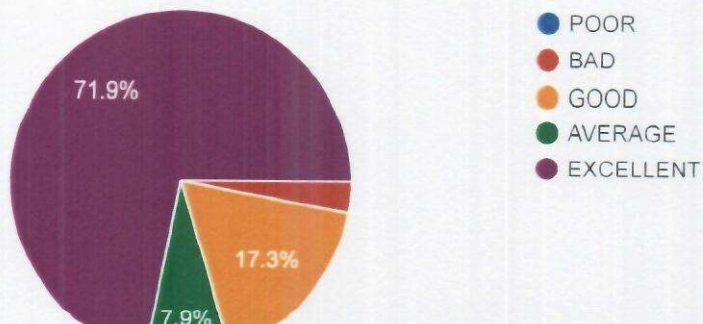



### SOLVING DOUBTS/ INTERACTION

 Copy

139 responses

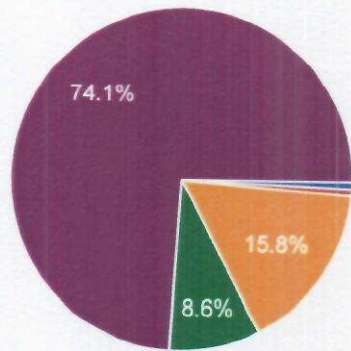

- POOR
- BAD
- GOOD
- AVERAGE
- EXCELLENT

### TIME MANAGEMENT

 Copy

139 responses

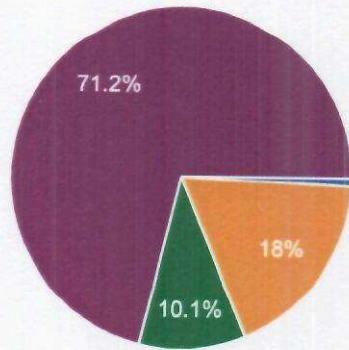

- POOR
- BAD
- GOOD
- AVERAGE
- EXCELLENT

### OVERALL RATING

 Copy

139 responses

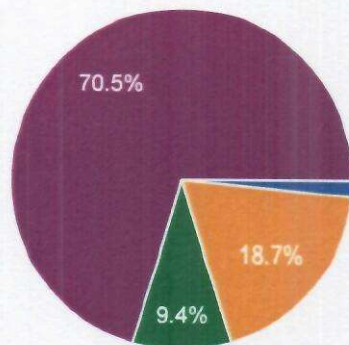

- POOR
- BAD
- GOOD
- AVERAGE
- EXCELLENT







# Feedback form\_INTERNSHIP\_3rd SEM\_Day 5\_15-10-2022

108 responses

[Publish analytics](#)

## Date

108 responses

Copy

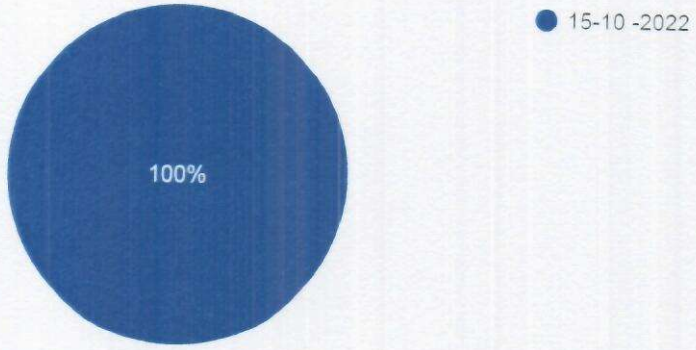

## Session

108 responses

Copy

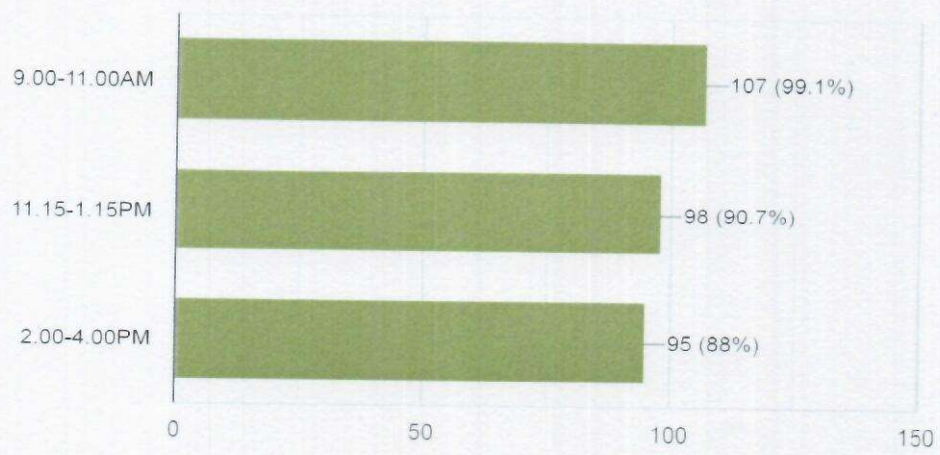



### TRAINER NAME

 Copy

108 responses

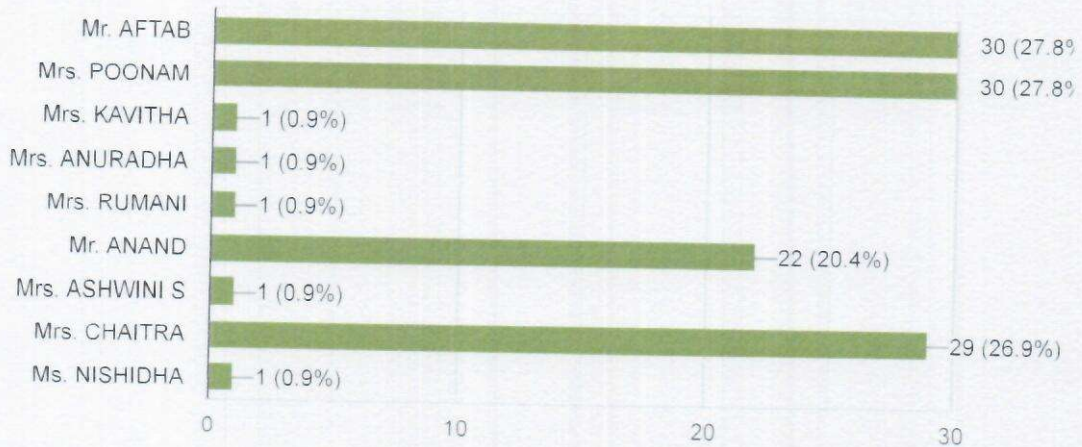

### TOPICS COVERED

 Copy

108 responses

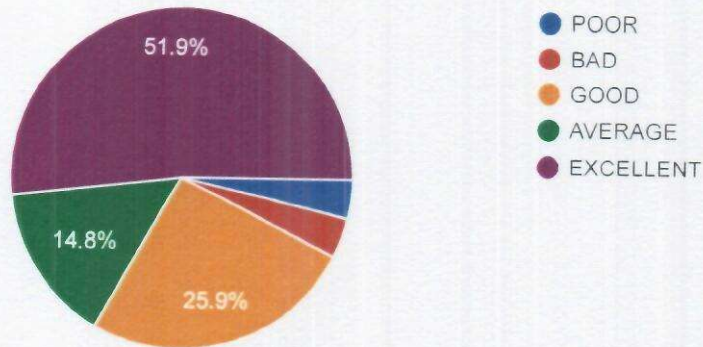

### CONCEPTUAL CLARITY/ SUBJECT KNOWLEDGE

 Copy

108 responses

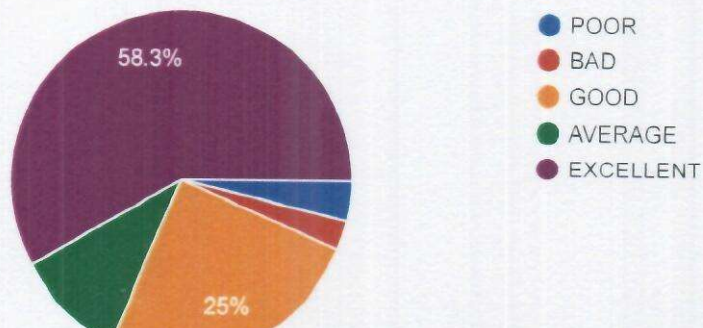



### SOLVING DOUBTS/ INTERACTION

 Copy

108 responses

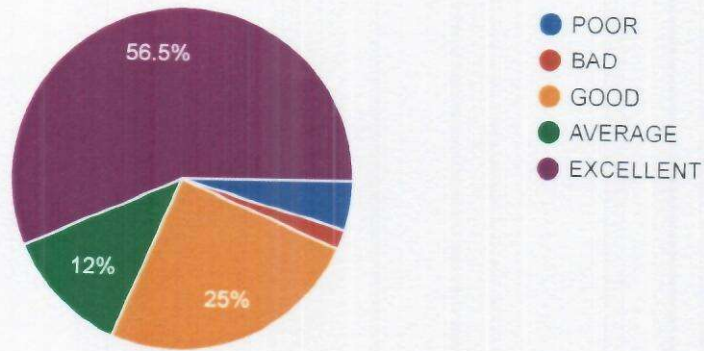

### TIME MANAGEMENT

 Copy

108 responses

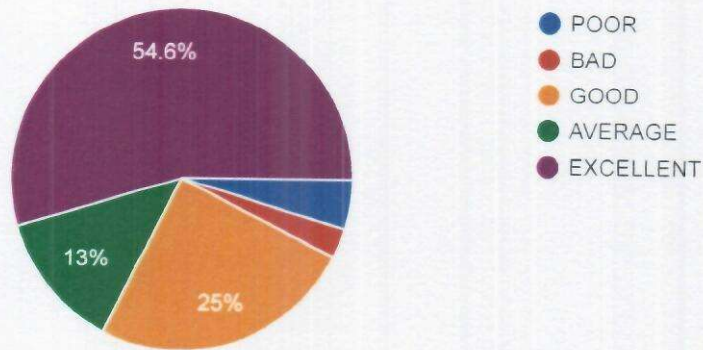

### OVERALL RATING

 Copy

108 responses

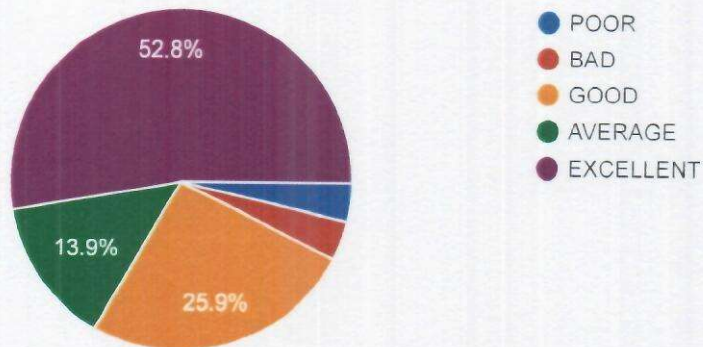



**AXIS BANK LTD**  
JPNAGAR, 6TH PHASE, BANAGLORE [K, BENGALURU, 560078  
IFS CODE - UTIB0001513

A/c Payee

VALID FOR THREE MONTHS FROM THE DATE OF ISSUE

DATE 2 4 0 8 2 0 2 3  
दिनांक D D M M Y Y Y Y

SESHAASAI (M) / CTS - 2010 02/05/2023 6347656

Pay **AUDAZ VENTURES PRIVATE LIMITED**

OR BEARER / या धारक को

रुपये Rupees **Two Lakh Twenty Three Thousand Six Hundred Twenty Four Only**

अदा करें

₹\*\*2,23,624.00

A/C NO. 912010014093916

For K S INSTITUTE OF TECHNOLOGY

PLTRS 000160

  
Authorised Signatory(ies)

Please sign above

Payable at par at all branches of Axis Bank Ltd in India.

⑈ 24 1 23 7 ⑈ 5602110341: 000160⑈ 31

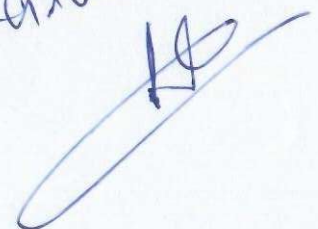
Received on 28/8/23  





**KSIT**  
K.S. INSTITUTE OF TECHNOLOGY

Kammavari Sangham (R) 1952  
K.S. GROUP OF INSTITUTIONS

ಕೆ.ಎಸ್. ತಾಂತ್ರಿಕ ಮಹಾವಿದ್ಯಾಲಯ

**K.S. INSTITUTE OF TECHNOLOGY**

Accredited By NAAC

# 14, Raghuvanahalli, Kanakapura Road, Bengaluru - 560 109.

Tel : 080 28435722 / 24, Fax : 080 28435723

E-mail : principal.ksit@gmail.com / principal@ksit.edu.in | website : www.ksit.edu.in

Ref: KSIT/PO/2022-2023/TPO 008

Date: 02/08/2023

To,  
Audaz Ventures Private Limited  
C-2 C-2/100, Janakpuri  
South Wesy, Delhi-110058

Dear Sir,

Sub: Purchase Order for Soft Skills Training Program for 2<sup>nd</sup> year B.E Students.

With reference to the above, we are pleased to place the order for Soft Skills Training Program for 4<sup>th</sup> Semester Students at K.S.Institute of Technology, #14, Raghuvanahalli, Kanakapura Road, Bangalore – 109 as per the following specifications, terms & conditions.

Programme Commercials:

Sl.No.	Description	Quantity	Rate	Amount
1	Soft Skills Training Program for First Year B.E Students.	406	Rs. 17/Hour/Student 406 × 30Hrs × 17Rs	2,07,060/-
	Total			2,07,060/-
	Taxable Value			
	ADD: (CGST 9% + SGST 9%) GST		18%	37,270/-
	Grand TOTAL			2,44,330/-
<u>Amount in Words:</u> Rupees Two Lakhs Forty Four Thousand And Three Thirty Only.				

Terms & Conditions:

- Training for 4th Semester students would be from 3<sup>rd</sup>-8<sup>th</sup> July 2023.
- Full Payment to be made post satisfactory completion of the training.

Thanking you,

  
Hon. Secretary

KAMMAVARI SANGHAM







K S GROUP OF INSTITUTIONS  
DEPARTMENT OF TRAINING AND PLACEMENTS  
COMPARATIVE STATEMENT OF TRAINING VENDORS

Name of Training Agency	Trainer Profile and Rating					Training Cost / Student / Hour
	1	2	3	4	5	
AUDAZ	Name	Qualification	Professional Experience	Specialization	Rating and Remarks	
	Asgar Pasha	B.Sc MBA, HR B.E	18 years	Personality Development	3+5 = 8	
	Bellappa	M.Tech	30 year	Soft Skills	4+5 = 9	
	Parvathi	B.A.M.A. MBA HR	18 years	Personality Development	3+5 = 8	AVG Score - 33/4 = 8.25 (Offline) = 20.5/Student/Hr + GST
	kavitha M	B.Sc (physics, maths & Electronics M.sc (Maths)	20 years	Aptitude & Soft Skills	3+5 = 8	
Assessment Portal-Own portal available						33

BIZOTIC	Srinath SETHURAMAN	M.Sc, MBA (UK)	20 Years	Soft Skills and Verbal	3+5 = 8	
	VINEET MANN	B.Sc , M.Sc	15 Years	Aptitude	3+5 = 8	
	SHASHIKALA MADHUSUDHAN	LLB, M.Sc	22 Years	Soft Skills and Verbal	3+5 = 8	
	K KRISHNA BAI	B.E, M.Tech (BSP)	10 Years	Technical & Aptitude	4+5 = 9	
Assessment- Own Portal Available						33

Quan Tech Origin	Deepak P.N.	B.E, M.E	08 Years	English and Soft skills	3+4 = 7	
	SAMUEL JOHN	Diploma (counseling skills), B.A	12 Years	Communication and Soft Skills	1+5 = 6	
	Vignesh M.K.	B.E	6 Years	Aptitude	2+3 = 5	
	Ananth P	B.E	15 Years	Technical & Aptitude	2 + 5 = 7	
Assessment -Own Portal Available						25

III Sem (KS)  
17+8796

IV Sem (KS)  
20+0288

+



Transit	Beena N	B Sc, MS, PGDBA	22 Years	Behaviour skills, Aptitude	4+5 = 9	AVG Score - 28/4 = 7 (Offline) = 23/Student/Hr + GST
	Sowmya Kerur	B E	08 Years	Aptitude	2+4 = 6	
	AMIT MONDLE		20 Years	Personality Development	2+3 = 5	
	Arun Kumar	M Sc, MBA	17 Years	Technical & Aptitude	3+5 = 8	
Assessment - Still Under Development					28	

MBA (I.E.)  
19+23

Skill Factory	Raghavan	B.Com & MBA (HR)	14 Years	Soft Skills and Verbal Skills	3+5 = 8	AVG Score - 33/4 = 8.25 ✓ (Offline) = 21/Student/Hr + GST
	Nisha	B Com & MBA (Fin)	10 Years	Logical, Analytical and Verbal	3+5 = 8	
	Dr. Jacob S	Ph.D	14 Years	Placement oriented skills, verbal skills	5+5 = 10	
	Narasimha	B E ( Information Science ) & MBA ( HR )	8 Years	Logical, Analytical and Verbal	3+4 = 7	
Assessment - Still Under Development					33	

(KSIT +  
VII Sem

Universal Education	Avishek Ghosh	B Sc, MBA	12 Years	Aptitude and Reasoning	3+5 = 8	AVG Score - 34/4 = 8.5 ✓ (Offline) = 22/Student/Hr + GST
	V Nandini Nair	B Sc, MBA	12 Years	Verbal and communication skills	3+5 = 8	
	Ahinshu Ghosh	B E, MBA	12 Years	Aptitude and Reasoning	4+5 = 9	
	Tapas Guha	B E, M Tech	12 Years	Technical Trainer	4+5 = 9	
Assessment - Still Under Development					34	

20+23

JV Global	Darshan B V	B E, Mtech	6 Years	Quantitative & Analytical	4 + 3 = 7	AVG Score - 31/4 = 7.75 ✓ (Offline) = 25/Student/Hr + GST
	Bhargav A P	BA, MA	10 Years	Soft skills	4 + 4 = 8	
	Beena N	B Sc, PG, MS, PGDBA	18 Years	Pre Placement Topics	4 + 5 = 9	
	Beena S	BE, Mtech	6 Years	Quantitative & Analytical	4 + 3 = 7	
					31	

Pentagon Space	Yashwanth K N	BBM, MBA	6 Years	Verbal and communication skills	3 + 3 = 6	AVG Score - 30/4 = 7.50 ✓ (Offline) = 32/Student/Hr + GST
	Hanu R	BE, M Tech	08 Years	Technical Trainer	4 + 4 = 8	
	DASHRATH MISAL	B Com, MA	15 Years	Soft skills and english	3 + 5 = 8	
	ARCHANA M S	B Com, MBA	13 Years	Soft skills	3 + 5 = 8	
					30	

Call the above for negotiations.

Chandru  
06/10/22

R. Gurus  
6/10/22





# K. S INSTITUTE OF TECHNOLOGY, BENGALURU-560109

14, Kanakapura Main Road, Raghuvanahalli, Bengaluru, Karnataka - 560109

## \*\* DEPARTMENT OF TRAINING AND PLACEMENTS \*\*

Date: 25/07/2023

### SOFT SKILLS TRAINING FOR 4<sup>th</sup> SEMESTER STUDENTS – 2025 BATCH

Placement Department has planned to conduct **Soft Skills Training Program** for 4<sup>th</sup> Semester students starting from **03/08/2023** to **08/08/2023** from **8.50 AM to 04.00 PM**. All HOD's are hereby requested to communicate their Second-year students regarding the same.

The training will be conducted in OB-Classrooms. Batch wise details are shared below. All placement coordinators are requested to submit the consolidated **attendance of all 5 days** to Placement Department and to take the **feedback** for all the days. Department wise schedule is given below for your reference.

Date	Time	Batch 1	Batch 2	Batch 3	Batch 4	Batch 5	Batch 6	Batch 7
		CSE	CSE	ECE	ECE	AIML	CSD	MECH+LATERAL ENTRIES FROM ALL BRANCHES
		A	B	A	B			
		Section	Section	Section	Section			
3 <sup>rd</sup> 4 <sup>th</sup> 5 <sup>th</sup> 7 <sup>th</sup> 8 <sup>th</sup> AUGUST 2023	8.50 AM - 11.00 AM	LH 104	LH 105	LH 007	LH 008	LH 401	LH 412	LH 106
	11.00 AM - 11.15 AM	Break						
	11.15AM - 1.15 PM	LH 104	LH 105	LH 007	LH 008	LH 401	LH 412	LH 106
	1.15 PM - 1.50 PM	Lunch Break						
	1.50 PM - 4.00 PM	LH 104	LH 105	LH 007	LH 008	LH 401	LH 412	LH 106

- All the students are informed to attend the session compulsorily **in Placement Dress code ONLY (Solid White Shirt and Black trousers)**.
- Students are strictly informed to be present in their allocated rooms only for all the five days. **DO NOT SWAP THE BATCHES.**
- Feedback QR code will be displayed in all the training rooms. **Students are informed to provide the feedback for each session before leaving the class.**
- Certificates will be given to those students who will have **100% attendance.**



*Shamas*  
**PRINCIPAL**  
**PRINCIPAL**  
**K.S. INSTITUTE OF TECHNOLOGY**  
**BENGALURU - 560 109.**

Cc to HOD's:

CSE <i>[Signature]</i>	ECE <i>[Signature]</i>	MECH <i>[Signature]</i>	AIML <i>[Signature]</i>	CSD <i>[Signature]</i>
------------------------	------------------------	-------------------------	-------------------------	------------------------





**\*\*DEPARTMENT OF TRAINING AND PLACEMENTS\*\***

Date: 26/07/23

**SOFT SKILLS TRAINING FOR 2<sup>ND</sup> AND 4<sup>TH</sup> SEMESTER STUDENTS**

Dear all,

This is to inform you that Placement Department is conducting soft skills training for the 2<sup>nd</sup> and 4<sup>th</sup> semester students of KSIT, the students are required to attend the training sessions without fail.

If anybody is absent for any of the sessions, he/she is liable to pay a fine equivalent to the training cost.

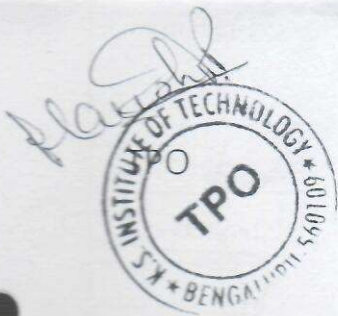

*Shumaa*  
PRINCIPAL  
PRINCIPAL  
K.S. INSTITUTE OF TECHNOLOGY  
BENGALURU - 560 109.

CC TO:

HODs and Coordinators of:

AIML <i>[Signature]</i>	CSE <i>[Signature]</i>	CSD <i>[Signature]</i>	ECE <i>[Signature]</i>	MECH <i>[Signature]</i>	AS & H <i>[Signature]</i>
----------------------------	---------------------------	---------------------------	---------------------------	----------------------------	------------------------------





# K. S INSTITUTE OF TECHNOLOGY, BENGALURU-560109

14, Kanakapura Main Road, Raghuvanahalli, Bengaluru, Karnataka - 560109

## 4<sup>TH</sup> SEM CLASS TEACHERS

SL NO	BRANCH&SECTION	CLASS TEACHERS NAME	DATE	SIGNATURE
1	CSE-A	Abhilash L Bhat	26/07/23	Abhilash
2	CSE-B	Namyapriya D	27/07/23	Namyapriya
3	ECE-A	Bhanumathi A	26/7/23	Bhanumathi
4	ECE-B	Anita P	26/7/23	Anita
5	AIML	LAKSHMI KK	26/7/23	Lakshmi
6	CSD	SUSHMA A	26/7/23	Sushma
7	MECH	HARISH U	27/7/23	Harish U

## 2<sup>ND</sup> SEM CLASS TEACHERS

SL NO	BRANCH & SECTION	CLASS TEACHER NAME	DATE	SIGNATURE
1	CSE-A	Radhika N.P	26/7/23	Radhika
2	CSE-B	Mamatha N	26/7/23	Mamatha
3	CSE-C	SHYLATA KR	26/07/23	Shylata
4	CSD-D	Dr. Harisha S	27/07/23	Harisha
5	AMIL-E	Lekshmi C	26/7/23	Lekshmi
6	ECE-F	Kanya T N	26/7/23	Kanya
7	ECE-G	Dr Renuka C	26/7/23	Renuka
8	IOT-H	Dr. Madhavi S	26/07/2023	Madhavi
9	CCE-I	Sneha G Kulkarni	26/07/2023	Sneha
10	MECH-J	TEJASWINI R	26.07.23	Tejaswini



APTITUDE TRAINING REPORT FOR KSIT

Date	Trainer's Name	Allotted Room	Duration	Topic Covered	Outcome
03/08/2023	Pruthvi	007	6 Hrs	<ul style="list-style-type: none"> <li>Averages</li> </ul>	Clarity about the Concept And solving the problems on the given module
	Jamuna	008		<ul style="list-style-type: none"> <li>Problems on Age</li> </ul>	
	Vikranth	104		<ul style="list-style-type: none"> <li>Speed, Distance and Time</li> </ul>	
	Abhishek	105		<ul style="list-style-type: none"> <li>Boat Problems</li> </ul>	
	Chethan	106		<ul style="list-style-type: none"> <li>Races</li> </ul>	
	Suma	401		<ul style="list-style-type: none"> <li>Train Problem</li> </ul>	
	Manohar	412			
04/08/2023	Abhishek	007	6 Hrs	<ul style="list-style-type: none"> <li>Profit and loss</li> </ul>	Clarity about the Concept And solving the Logic and problems on Profit/Loss/Percentage questions and other Modules
	Manohar	008		<ul style="list-style-type: none"> <li>Discount</li> </ul>	
	Suma	104		<ul style="list-style-type: none"> <li>Number System</li> </ul>	
	Vikranth	105		<ul style="list-style-type: none"> <li>Percentage</li> </ul>	
	Prithvi	106			
	Jamuna	401		<ul style="list-style-type: none"> <li>Partnership</li> </ul>	
	Chethan	412			



Date	Trainer's Name	Allotted Room	Duration	Topic Covered	Outcome
05/08/2023	Abhishek	007	6 Hrs	<ul style="list-style-type: none"> <li>• Time and work- Individual</li> </ul>	Understanding the concept behind the Problems and building IQ level by Solving it
	Vikranth	008		<ul style="list-style-type: none"> <li>• Time and Work - Group</li> </ul>	
	Jamuna	104		<ul style="list-style-type: none"> <li>• Pipes and Cisterns</li> </ul>	
	Suma	105		<ul style="list-style-type: none"> <li>• Permutation and Combinations</li> </ul>	
	Chethan	106		<ul style="list-style-type: none"> <li>• Probability</li> </ul>	
	Pruthvi	401		<ul style="list-style-type: none"> <li>• Progressions</li> </ul>	
	Manohar	412			
07/08/2023	Vikrant	007	6 Hrs	<ul style="list-style-type: none"> <li>• Simple and Compound Interest</li> </ul>	Clarity about the Concept And solving the problems on the given module
	Manohar	008		<ul style="list-style-type: none"> <li>• Ratio and Proportions</li> </ul>	
	Prithvi	104		<ul style="list-style-type: none"> <li>• Allegations and mixtures</li> </ul>	
	Jamuna	105		<ul style="list-style-type: none"> <li>• Data Sufficiency - 1</li> </ul>	
	Manish	106		<ul style="list-style-type: none"> <li>• Letter Series</li> </ul>	
	Abhishek	401		<ul style="list-style-type: none"> <li>• Blood Relations</li> </ul>	
	Chethan	412			



Date	Trainer's Name	Allotted Room	Duration	Topic Covered	Outcome
08/08/2023	Jamuna	007	6 Hrs	<ul style="list-style-type: none"><li>• Coding and decoding</li></ul>	Understanding the concept behind the Problems and building IQ level by Solving them
	Chethan	008		<ul style="list-style-type: none"><li>• Clocks</li></ul>	
	Abhishek	104		<ul style="list-style-type: none"><li>• Calendar</li></ul>	
	Prithvi	105		<ul style="list-style-type: none"><li>• Direction Sense</li></ul>	
	Manohar	106		<ul style="list-style-type: none"><li>• Seating Arrangement</li></ul>	
	Manish	401		<ul style="list-style-type: none"><li>• Syllogism</li></ul>	
	Vikrant	412			



**K S INSTITUTE OF TECHNOLOGY**  
**DEPARTMENT OF TRAINING AND PLACEMENTS**  
**CONSOLIDATED ATTENDANCE FOR SOFT SKILL TRAINING**

2ND YEAR CSE-A			4TH SEMESTER						CSE-A(LH-104)								
S. No	USN	NAME OF THE STUDENT	Dates														
			03/08/23			04/08/2023			05/08/2023			07/08/2023			08/08/2023		
			1	2	3	4	5	6	7	8	9	10	11	12	13	14	15
1	IKS21CS001	A RAMYASREE	P	P	P	P	P	P	P	P	P	P	P	P	P	P	P
2	IKS21CS002	AARYA M	P	P	P	P	P	P	P	P	P	P	A	A	P	P	P
3	IKS21CS003	ABHILASHA V	P	P	P	P	P	P	P	P	P	P	P	P	P	P	P
4	IKS21CS004	ABHIRAM K	P	P	P	P	P	P	P	P	A	P	P	P	P	P	P
5	IKS21CS005	ABHIRAM YADATORE SHANTARAM	P	P	P	P	P	P	P	P	P	P	P	P	P	P	P
6	IKS21CS006	ADITHI R	P	P	P	P	P	P	P	P	P	P	P	P	P	P	P
7	IKS21CS007	ADITHI S REDDY	P	P	P	P	P	P	P	P	P	P	P	P	P	P	P
8	IKS21CS008	ADITYA V	P	P	P	P	P	P	P	P	P	P	P	P	P	P	P
9	IKS21CS009	AFIFAH AYESHA BIJLI	P	P	P	P	P	P	P	P	P	P	P	P	P	P	P
10	IKS21CS010	AISHWARYA G	P	P	P	P	P	P	P	P	P	P	P	P	P	P	P
11	IKS21CS011	AKSHAY VIVEKANANDA B	P	P	P	P	P	P	P	P	P	P	A	A	A	A	A
12	IKS21CS012	ANANYA PRASAD S	P	P	P	P	P	P	P	P	P	P	P	P	P	P	P
13	IKS21CS014	ARCHANA P	P	P	P	P	P	P	P	P	P	P	P	P	P	P	P
14	IKS21CS015	ARTHAN M GOWDA	P	P	P	P	P	P	P	P	P	P	P	A	P	P	P
15	IKS21CS016	ASHA H P	P	P	P	P	P	P	P	P	P	P	P	P	P	P	P
16	IKS21CS017	ASHWINI	P	P	P	P	P	P	P	P	P	P	P	P	P	P	P
17	IKS21CS018	B G PRAJWAL	P	P	P	P	P	P	P	P	P	P	P	P	P	P	P
18	IKS21CS020	BHAVANA B	P	P	P	P	P	P	P	P	P	P	P	P	P	P	P
19	IKS21CS021	CHAITRA M	P	P	P	P	P	P	P	P	P	P	P	P	P	P	P
20	IKS21CS022	CHARISHMA A	P	P	P	P	P	P	P	P	P	P	P	P	P	P	P
21	IKS21CS023	CHARISHMA M	P	P	P	P	P	P	P	P	P	P	P	P	P	P	P
22	IKS21CS024	CHEZHAN H	P	P	P	P	P	P	P	P	P	P	A	A	A	P	P
23	IKS21CS025	DARSHAN S	P	P	P	P	P	P	P	P	P	P	P	P	P	P	P
24	IKS21CS026	DEEPTHI A B	A	A	A	P	P	P	P	P	P	P	P	P	P	P	P
25	IKS21CS027	DHRUTHI UMESH S	P	P	P	A	A	A	A	A	A	A	A	A	A	A	A
26	IKS21CS028	D L SHIVANG	P	P	P	P	P	P	P	P	P	P	P	P	P	P	P
27	IKS21CS029	GAANA S	P	P	P	P	P	P	P	P	P	P	A	A	A	A	A
28	IKS21CS030	GAGAN SHIVANNA	P	P	P	P	P	P	P	P	P	P	P	P	P	P	P
29	IKS21CS031	GOPALA KRISHNA V	P	P	P	P	P	P	P	P	P	P	A	A	A	A	A
30	IKS21CS032	GURUPRASAD Y S	P	P	P	P	P	P	P	P	P	P	P	P	P	P	P
31	IKS21CS033	HARSHITHA K M	P	P	P	P	P	P	P	P	P	P	P	P	P	P	P
32	IKS21CS034	HARSHITHA P	P	P	P	P	P	P	P	P	P	P	P	P	P	P	P
33	IKS21CS035	HARSHITHA R	P	P	P	P	P	P	P	A	P	P	P	P	P	P	P
34	IKS21CS036	HARSHITHA S	P	P	P	P	P	P	P	P	P	P	P	P	P	P	P
35	IKS21CS037	HARSHITHA S	P	P	P	P	P	P	P	P	P	P	P	P	P	P	P
36	IKS21CS038	HEMANTH KUMAR V	P	P	P	P	P	P	P	P	P	P	P	A	P	P	P
37	IKS21CS039	HRITHIKA V	P	P	P	P	P	P	P	P	P	P	P	P	P	P	P
38	IKS21CS040	IBBANI V GOWDA	P	P	P	P	P	P	P	P	P	P	P	P	P	P	P
39	IKS21CS041	IMAN GHORAI	P	P	P	P	P	P	P	P	A	P	P	P	P	P	P
40	IKS21CS042	JAHNAVI P	P	P	P	P	P	P	P	P	P	P	P	P	P	P	P
41	IKS21CS043	JASHWANTH P C	P	P	P	P	P	P	P	P	P	P	P	P	P	P	P
42	IKS21CS045	KANISHK E R	P	P	P	P	P	P	P	P	A	P	P	P	P	P	P
43	IKS21CS046	KARTHIK H N	P	P	P	P	P	P	P	P	P	P	P	P	P	P	P
44	IKS21CS047	KAUSHIK G V	P	P	P	P	P	P	P	P	P	P	P	P	P	P	P
45	IKS21CS048	KAVANA N	P	P	P	P	P	P	P	P	P	P	P	P	P	P	P
46	IKS21CS049	KAVYA B SINGH	P	P	P	P	P	P	P	P	P	P	P	P	P	P	P
47	IKS21CS050	KEERTHIKA S	P	P	P	P	P	P	P	P	P	P	P	P	P	P	P
48	IKS21CS051	KONGARA SREE SAI	A	P	P	P	P	P	P	P	P	P	P	P	A	P	P



























1 2 3 4 5 6 7 8 9 10 11 12 13 14 15

45	1KS21EC109	UDAYA KUMAR S R	1	1	A	1	P	P	P	P	A	P	P	P	*	A	A
46	1KS21EC110	VAISHNAVI B A	1	1	1	1	P	P	P	P	A	P	P	P	P	P	P
47	1KS21EC111	VARSHA JAYAKUMAR	1	1	1	1	P	P	P	P	A	P	P	P	P	P	P
48	1KS21EC112	VARSHA S DAVASKAR	1	1	1	1	P	P	P	P	A	P	P	P	P	P	P
49	1KS21EC113	VARSHITH S	1	1	A	1	P	P	P	P	A	P	P	P	P	P	P
50	1KS21EC114	VEERESH K N	1	1	1	A	A	A	A	P	P	A	P	P	P	A	A
51	1KS21EC115	VIDYA I	A	A	A	1	P	P	P	P	A	P	P	P	P	P	P
52	1KS21EC116	VIDYA RAWAL D	A	A	A	1	P	P	P	P	A	P	P	P	P	P	P
53	1KS21EC117	VIDYASHREE R	1	1	1	1	P	P	A	A	A	P	P	P	P	P	P
54	1KS21EC118	VIJAY YADAV R	1	1	1	1	P	P	*	P	A	P	P	P	P	P	A
55	1KS21EC120	VYSHAK G R	1	1	1	1	P	P	P	P	P	P	P	P	P	P	P
56	1KS21EC121	YASHWANTH.M	1	1	A	1	P	P	P	P	P	P	P	P	P	P	P
NO. OF STUDENTS ABSENT			1	1	1	1	7	9	17	9	22	10	4	4B	4B	4B	4B
NO. OF STUDENTS PRESENT			10	10	25	7	45	47	40	48	34	4B	32	P	45	45	33
SIGNATURE OF CLASS TEACHE' RS			AP	A	AP	AP	AD	AP	AP	AP	AP	AP	AP	AP	AP	AP	AP

Faint, mostly illegible handwriting on lined paper, possibly representing a continuation of the attendance record or other class notes.



K S INSTITUTE OF TECHNOLOGY																	
DEPARTMENT OF TRAINING AND PLACEMENTS																	
CONSOLIDATED ATTENDANCE FOR SOFT SKILL TRAINING																	
2ND YEAR AIML			4TH SEMESTER						AIML (LH-104)								
S. No	USN	NAME OF THE STUDENT	Dates														
			03/08/23			04/08/2023			05/08/2023			07/08/2023			08/08/2023		
			1	2	3	4	5	6	7	8	9	10	11	12	13	14	15
1	1KS20AI024	MOHAMMED ZEESHAN	A	A	A	A	A	A	1	2	3	4	5	6	7	8	9
2	1KS20AI029	PAVAN A	A	A	A	A	A	1	2	3	4	5	6	7	8	9	10
3	1KS20AI040	SYED AASIM HUBAIRA	1	2	3	4	5	6	7	8	9	10	11	12	13	14	15
4	1KS21AI001	ABHAY SURYA E	A	A	A	1	2	3	4	5	6	7	8	9	10	11	12
5	1KS21AI002	ADITHI R	1	2	3	4	5	6	7	8	9	10	11	12	13	14	15
6	1KS21AI003	ADITYA KALKUR	1	2	3	4	5	6	7	8	9	10	11	12	13	14	15
7	1KS21AI004	AMRUTHA M V	1	2	3	4	5	6	7	8	9	10	11	12	13	14	15
8	1KS21AI005	ANANYA B GOWDA	1	2	3	4	5	6	7	8	A	9	10	11	12	13	14
9	1KS21AI006	ANANYA PRAMOD	1	2	3	4	5	6	7	8	9	A	10	11	12	13	14
10	1KS21AI007	ANUSHREE R	1	2	3	4	5	6	7	8	9	10	11	12	13	14	15
11	1KS21AI008	APEKSHA I M	1	2	3	4	5	6	7	8	9	10	11	12	13	14	15
12	1KS21AI009	ARVIND N	1	2	3	4	5	6	7	8	9	10	11	12	13	14	15
13	1KS21AI010	BHUVAN S GOWDA	1	2	3	A	4	5	6	7	8	9	10	11	12	13	14
14	1KS21AI011	CHAITRA S	1	2	3	4	5	6	7	8	9	10	11	12	13	14	15
15	1KS21AI012	CHEZHAN S	1	2	3	4	5	6	7	8	9	10	11	12	13	14	15
16	1KS21AI013	CHIRAG V S	1	2	3	4	5	6	7	A	8	9	10	11	12	13	14
17	1KS21AI014	ESHWAR S	1	2	3	4	5	6	7	8	9	A	10	11	12	13	14
18	1KS21AI015	G C SAMBRAM	1	2	3	4	5	6	7	8	9	10	11	12	13	14	15
19	1KS21AI016	G VINAY KUMAR	1	2	3	4	5	6	7	8	9	10	11	12	13	14	15
20	1KS21AI017	HARIKRISHNA G	1	2	3	4	5	6	7	8	9	10	11	12	13	14	15
21	1KS21AI018	HARSHITHA A	1	2	3	4	5	6	7	8	9	10	11	12	13	14	15
22	1KS21AI019	HEMALATHA D R	1	2	3	4	5	6	7	8	9	10	11	12	13	14	15
23	1KS21AI020	JAYASHREE P R	1	2	3	4	5	6	7	8	9	10	11	12	13	14	15
24	1KS21AI021	K J ARUN	1	2	3	4	5	6	7	8	9	10	11	12	13	14	15
25	1KS21AI022	KARTHIK CHAVAN	1	2	3	4	5	6	7	8	9	10	11	12	13	14	15
26	1KS21AI023	KAVYA S	1	2	3	4	5	6	7	8	9	10	11	12	13	14	15
27	1KS21AI024	KEERTHANA R	1	2	3	4	5	6	7	8	9	10	11	12	13	14	15
28	1KS21AI025	LIKITHA K	1	2	3	4	5	6	7	8	9	A	A	A	10	11	12
29	1KS21AI026	LOCHAN K	1	2	3	4	5	6	7	8	9	10	11	12	13	14	15
30	1KS21AI027	LOKARANJAN B S	1	2	3	4	5	6	7	8	9	10	11	12	13	14	15
31	1KS21AI028	MODUPALLI MEGHANA	A	1	2	3	A	A	4	5	6	7	8	9	A	A	A
32	1KS21AI029	MRUDULA S R	1	2	3	4	5	6	7	8	9	10	11	12	13	14	15
33	1KS21AI030	NABIHA SHARIFF	1	2	3	4	5	6	7	8	9	10	11	12	13	14	15
34	1KS21AI031	NEERAJ P	A	A	A	1	2	3	4	5	6	7	8	9	10	11	12
35	1KS21AI032	NEHA K B	1	2	3	4	5	6	7	8	9	10	11	12	13	14	15







**K S INSTITUTE OF TECHNOLOGY**

**DEPARTMENT OF TRAINING AND PLACEMENTS**

**CONSOLIDATED ATTENDANCE FOR SOFT SKILL TRAINING**

**2ND YEAR -CSD**

**4TH SEMESTER**

**CSD-(LH-412)**

S. No	USN	NAME OF THE STUDENT	Dates														
			03/08/23			04/08/2023			05/08/2023			07/08/2023			08/08/2023		
			1	2	3	4	5	6	7	8	9	10	11	12	13	14	15
1	1KS21CG001	A S N SREEYA	1	2	3	4	5	6	7	8	9	10	11	12	13	14	15
2	1KS21CG002	ABDUS SALAAM I	1	2	A	4	5	6	7	8	9	A	A	A	10	11	12
3	1KS21CG003	ABHILASHA PATIL	1	2	3	4	5	6	7	8	9	10	11	12	13	14	15
4	1KS21CG004	ANAGHA SHASTRY	1	2	3	4	5	6	7	8	9	10	11	12	13	14	15
5	1KS21CG005	ANKITHA DEVLOKAM	1	2	3	4	5	6	7	8	9	10	11	12	13	14	15
6	1KS21CG006	ARPITHA G R	1	2	3	4	5	6	7	8	9	10	11	12	13	14	15
7	1KS21CG007	B H RUCHIRA	1	2	3	4	5	6	7	8	9	10	11	12	13	14	15
8	1KS21CG008	BADARI PRASAD M	1	2	3	4	5	6	7	8	9	10	11	12	13	14	15
9	1KS21CG009	BHARAT R	1	2	3	4	5	6	7	8	9	10	11	12	13	14	15
10	1KS21CG011	CHALLA DEEPIKA	1	2	3	4	5	6	7	8	9	10	11	12	13	14	15
11	1KS21CG012	DANDA AJITH KUMAR	1	2	3	4	5	6	7	8	9	10	11	12	13	14	15
12	1KS21CG013	DEEPIKA S	1	2	3	4	5	6	7	8	9	10	11	12	13	14	15
13	1KS21CG014	DEEPTHI G B	1	2	3	4	5	6	7	8	9	10	11	12	13	14	15
14	1KS21CG015	DHANUSH B K	1	2	3	4	5	6	7	8	9	10	11	12	13	14	15
15	1KS21CG016	DIVYA T	1	2	3	4	5	6	A	A	A	7	8	09	10	11	12
16	1KS21CG017	G PRADEEP	1	2	3	4	5	6	7	8	9	10	11	12	13	14	15
17	1KS21CG018	G YOGIRAM	1	2	3	4	5	6	7	8	9	10	11	12	13	14	15
18	1KS21CG019	GOVIND VENKATESHA SHETTY	1	2	3	4	5	6	7	8	9	10	11	12	13	14	15
19	1KS21CG020	HEMANTH M	1	2	3	4	5	6	7	8	9	10	11	12	13	14	15
20	1KS21CG021	KARTHIK C S	1	2	3	4	5	6	7	8	9	10	11	12	13	14	15
21	1KS21CG022	KEERTHANA LOKESH	1	2	3	4	5	6	7	8	9	10	11	12	13	14	15
22	1KS21CG023	KEERTHANA S	1	2	3	4	5	6	7	8	9	10	11	12	13	14	15
23	1KS21CG024	KEERTHANA S D	1	2	3	4	5	6	7	8	9	10	11	12	13	14	15
24	1KS21CG025	KUSHAL M J	1	2	3	4	5	6	7	8	9	10	11	12	13	14	15
25	1KS21CG026	KUSUM PAKIRA	1	2	3	4	5	6	7	8	9	10	11	12	13	14	15
26	1KS21CG027	MONISHA M															
27	1KS21CG028	NEHA M R	1	2	3	4	5	6	7	8	9	10	11	12	13	14	15
28	1KS21CG029	NISHANTH G K	A	A	A	1	2	3	4	5	6	7	8	9	10	11	12
29	1KS21CG030	PAVITHRAA G	1	2	3	4	5	6	7	8	9	10	11	12	13	14	15
30	1KS21CG031	PRATEEK C HIREMATH	1	2	3	4	5	6	7	8	9	10	11	12	13	14	15
31	1KS21CG032	PREETHAM H V	1	2	3	4	5	6	7	8	9	10	11	12	13	14	15
32	1KS21CG033	RAYALA SAI PRAKASH	1	2	3	4	5	6	7	8	9	10	11	12	13	14	15
33	1KS21CG034	RIYA NAIR	1	2	3	4	5	6	7	8	9	10	11	12	13	14	15
34	1KS21CG035	SANJANA SREENIVAS	1	2	3	4	5	6	7	8	9	10	11	12	A	A	A
35	1KS21CG036	SANJANA V	1	2	3	4	5	6	7	8	9	10	11	12	13	14	15
36	1KS21CG037	SANJAY P	1	2	3	4	5	6	7	8	9	10	11	12	13	14	15
37	1KS21CG038	SATHYA SAI SRI B S	1	2	3	4	5	6	7	8	9	10	11	12	13	14	15
38	1KS21CG039	SAVYASHREE S	1	2	3	4	5	6	7	8	9	10	11	12	13	14	15
39	1KS21CG040	SHALINI B	1	2	3	4	5	6	7	8	9	10	11	12	13	14	15











SL NO	USN	NAME OF THE STUDENT	1	2	3	4	5	6	7	8	9	10	11	12	13	14	15
32	1KS22CS414	SOUNDARYA K S	P	P	P	P	P	P	P	P	P	P	P	P	P	P	P
33	1KS22CS415	SPANDANA M	P	P	P	P	P	P	P	P	P	P	P	P	P	P	P
34	1KS22CS416	VEDASHREE S	P	P	P	P	P	P	P	P	P	P	P	P	P	P	P
35	1KS22EC400	ADITHYA D		A	P	P	P	P	P	P	P	P	P	P	P	P	P
36	1KS22EC401	APOORVA B		P	P	P	P	P	P	P	P	P	P	P	P	P	P
37	1KS22EC402	B SREEPADREDDY H BULLANGOUDAR		P	P	P	P	P	P	P	P	P	P	P	P	P	P
38	1KS22EC403	CHAITRA N		P	P	P	P	P	P	P	P	P	P	P	P	P	P
39	1KS22EC404	GONUGUNTLA SHRUJANA		P	P	P	P	P	P	P	P	P	P	P	P	P	P
40	1KS22EC405	HEMA K		P	P	P	P	P	P	P	P	P	P	P	P	P	P
41	1KS22EC406	PAVANGOWDA H P		P	P	P	P	P	P	P	P	P	P	P	P	P	P
42	1KS22EC407	PRAJWAL PATIL B S		P	P	P	P	P	P	P	P	P	P	P	P	P	A
43	1KS22EC408	SANGEETHA H M		P	P	P	P	P	P	A	A	P	P	P	P	P	P
44	1KS22EC409	SOUNDARYA S		P	P	P	P	P	P	P	P	P	P	P	P	P	P
45	1KS22EC410	SOWMYA A M		P	P	P	P	P	P	P	P	P	P	P	P	P	P
46	1KS22EC411	SUDEEP P		P	P	P	P	P	P	P	P	P	P	P	P	P	P
47	1KS22EC412	VAISHNAVI V		P	P	P	P	P	P	P	P	P	P	A	A	A	A
48	1KS22AI400	AVINASH P		P	P	P	P	P	P	P	P	P	P	P	P	P	P
49	1KS22AI401	CETHAN N		P	P	P	P	P	P	P	P	P	P	P	P	P	P
50	1KS22AI402	K JAHNAVI		P	P	P	P	P	P	P	P	P	P	P	P	P	P
51	1KS22AI403	RISHI S		P	P	P	P	P	P	P	P	P	P	P	P	P	P
52	1KS22AI404	SAHU DURGAMADHAB SARATKUMAR		P	P	P	P	P	A	A	A	P	P	P	A	A	A
53	1KS22AI405	SANJAY K U		P	P	P	P	P	P	P	P	P	P	P	P	P	P
54	1KS22AI406	ULLAS B		P	P	P	P	P	P	P	P	A	A	A	A	A	A
55	1KS22CG400	ARUN A		P	P	P	P	P	P	P	P	P	P	P	P	P	P
56	1KS22CG401	CHANDRASEKAR A		P	P	P	P	P	P	P	P	P	P	P	P	P	P
57	1KS22CG402	MAYURGANAPATI S BADGHRI		P	P	P	P	P	P	P	P	P	P	P	P	P	P
58	1KS22CG403	NANDISH K S		P	P	P	P	P	P	P	P	P	P	P	P	P	P
59	1KS22CG404	PURUSHOTHAM V MITTI		P	P	P	P	P	P	P	P	P	P	P	P	P	P
60	1KS22CG405	PUTTUR PRAVEEN KUMAR		P	P	P	P	P	P	P	P	P	P	P	P	P	P
61	1KS22CG406	SHARATH N		P	P	P	P	P	P	P	P	P	P	P	P	P	P
62	1KS22CG407	SHRUTHI M		P	P	P	P	P	P	P	P	P	P	P	P	P	P
63	1KS22CG408	SUSHIL WAGHAMARE		P	P	P	P	P	P	P	P	P	P	P	P	P	P
NO OF STUDENTS ABSENT				01	02	01	01		06	05	19	06	04	09	30	06	07
NO OF STUDENTS PRESENT				62	61	62	62	58	58	58	44	57	59	54	60	57	56
SIGNATURE OF CLASS TEACHERS				<i>[Signature]</i>	<i>[Signature]</i>	<i>[Signature]</i>	<i>[Signature]</i>	<i>[Signature]</i>	<i>[Signature]</i>	<i>[Signature]</i>	<i>[Signature]</i>	<i>[Signature]</i>	<i>[Signature]</i>	<i>[Signature]</i>	<i>[Signature]</i>	<i>[Signature]</i>	<i>[Signature]</i>

3  
60  
*[Signature]*







SESHAASA (M) / CTS - 2010 13/10/2022 5487806



**AXIS BANK LTD**

JPNAGAR, 6TH PHASE, BANAGLORE [K], BENGALURU, 560078  
IFS CODE - UTIB0001513

**A/C. PAYEE ONLY**

VALID FOR THREE MONTHS FROM THE DATE OF ISSUE

DATE 05/12/2022  
दिनांक D D M M Y Y Y Y

Pay Bizotic Edtech Pvt Ltd

OR BEARER / या धारक को

रुपये Rupees One lach eighty four thousand  
82 hundred eighty only

अदा करें ₹ 1,84,680/-

A/C NO. 912010014093916

PLTRS 000160

For K S INSTITUTE OF TECHNOLOGY

Payable at par at all branches of Axis Bank Ltd in India.

Authorised Signatory(ies)  
Please sign above

⑈ 229356 ⑈ 5602110341 ⑈ 000160 ⑈ 31

Received on 8th Dec 2022





**KSIT**  
K.S. INSTITUTE OF TECHNOLOGY

Kammavari Sangham (R) 1952  
K.S. GROUP OF INSTITUTIONS

ಕೆ.ಎಸ್. ತಾಂತ್ರಿಕ ಮಹಾವಿದ್ಯಾಲಯ

**K.S. INSTITUTE OF TECHNOLOGY**

Accredited By NAAC

# 14, Raghuvanahalli, Kanakapura Road, Bengaluru - 560 109.

Tel : 080 28435722 / 24, Fax : 080 28435723

E-mail : principal.ksit@gmail.com / principal@ksit.edu.in | website : www.ksit.edu.in

Ref: KSIT/PO/2022-2023/TPO 007

Date: 10/11/2022

To,  
Bizotic Edtech Private Ltd  
#15, 3<sup>rd</sup> Main, 3<sup>rd</sup> Cross, Maruthi Nagar, Shreyas Colony  
J.P Nagar 7<sup>th</sup> Phase, Bengaluru - 560078

Dear Sir,

**Sub:** Purchase Order for Personality Development Training Program for 5<sup>th</sup> Semester B.E Students.

With reference to the above, we are pleased to place the order for **Personality Development Training Program for 5<sup>th</sup> Semester Students** at **K.S. Institute of Technology**, #14, Raghuvanahalli, Kanakapura Road, Bangalore – 109 as per the following specifications, terms & conditions.

**Programme Commercials:**

Sl.No.	Description	Quantity	Rate	Amount
1	Personality Development Training Program for 5 <sup>th</sup> BE Students	285	Rs. 20/Hour/Student (285 × 30Hrs × 20Rs)	1,71,000/-
	Total			1,71,000/-
	Taxable Value			30,780/-
	ADD: CGST 9%			15,390/-
	ADD: SGST 9%			15,390/-
	<b>Grand TOTAL</b>			<b>2,01,780.00/-</b>
Amount in Words: Rupees Two Lakh One Thousand and Seven Hundred Eight Only				

**Terms & Conditions:**

- Training for 5<sup>th</sup> Semester students would be from 17<sup>th</sup> – 23<sup>rd</sup> November 2022.
- Pre assessment test would be conducted on 16/11/2022 and post assessment test on 26/11/2022 at company portal only and report to be submitted on or before 28/11/2022.
- Full Payment to be made post satisfactory completion of the training.

Thanking you,

Hon. Secretary 30/11/22



K S GROUP OF INSTITUTIONS  
DEPARTMENT OF TRAINING AND PLACEMENTS  
COMPARATIVE STATEMENT OF TRAINING VENDORS

Name of Training Agency	Trainer Profile and Rating					Training Cost / Student / Hour
	1	2	3	4	5	
AUDAZ	Asgar Pasha	B.Sc MBA HR B.E.	18 years	Personality Development	3+5 = 8	AVG Score - 33/4 = 8.25 (Offline) = 20.5/Student/Hr + GST
	Belliappa	M.Tech	30 year	Soft Skills	4+5 = 9	
	Parvathi	B.A.M.A. MBA HR	18 years	Personality Development	3+5 = 8	
	Kavitha M	B.Sc (physics, maths & Electronics) M.sc (Maths)	20 years	Aptitude & Soft Skills	3+5 = 8	
Assessment Portal-Own portal available					33	

III Sem (KSIT)  
17+67.80

BIZOTIC	SRINATH SETHURAMAN	M.Sc, MBA (UK)	20 Years	Soft Skills and Verbal	3+5 = 8	AVG Score - 33/4 = 8.25 (Offline) = 20/Student/Hr + GST
	VINEET MANN	B.Sc, M.Sc	15 Years	Aptitude	3+5 = 8	
	SHASHIKALA MADHUSUDHAN	LLB, M.Sc	22 Years	Soft Skills and Verbal	3+5 = 8	
	K KRISHNA BAI	B.E, M.Tech (BSP)	10 Years	Technical & Aptitude	4+5 = 9	
Assessment- Own Portal Available					33	

IV Sem (KSIT)  
20+65.80

Quan Tech Origin	Deepak P.N.	B.E, M.E	08 Years	English and Soft skills	3+4 = 7	AVG Score - 25/4 = 6.25 (Offline) = 20/Student/Hr + GST
	SAMUEL JOHN	Diploma (counselling skills), B.A	12 Years	Communication and Soft Skills	1+5 = 6	
	Vignesh M.K.	B.E	6 Years	Aptitude	2+3 = 5	
	Ananth P	B.E	15 Years	Technical & Aptitude	2+5 = 7	
Assessment-Own Portal Available					25	

X



Talent	Bhomi N	B.Sc, MS, PGDDBA	22 Years	Behaviour skills, Aptitude	4+5=9	AVG Score - 284 = 7 (Offline) = 23 Student/Hr + GST
	Sowmya Karut	B.E	08 Years	Aptitude	2+4=6	
	AMIT MONTRE		20 Years	Personality Development	2+3=5	
	Arun Kumar	M.Sc, MBA	17 Years	Technical & Aptitude	3+5=8	
Assessment - Skill Under Development					28	
Skill Factory	Raghavan	B.Com & MBA (HR)	14 Years	Soft Skills and Verbal Skills	3+5=8	AVG Score - 334 = 8.25 (Offline) = 21 Student/Hr + GST
	Nirha	B.Com & MBA (Fin)	10 Years	Logical, Analytical and Verbal	3+5=8	
	Dr. Jacob S	Ph.D	14 Years	Practise oriented skills, verbal skills	5+5=10	
	Narasimha	Ph.D (INTEGRATION Science) & MBA (HR)	8 Years	Logical, Analytical and Verbal	3+4=7	
Assessment - Skill Under Development					33	
Universal Education	Ayubek Ullash	B.Sc, MBA	12 Years	Aptitude and Reasoning	3+5=8	AVG Score - 324 = 8.5 (Offline) = 23 Student/Hr + GST
	V Nandini Nair	B.Sc, MBA	12 Years	Verbal and communication skills	3+5=8	
	Akhya Ullash	B.E, MBA	12 Years	Aptitude and Reasoning	4+5=9	
	Umesh Gaha	B.E, M.Tech	12 Years	Technical Trainer	4+5=9	
Assessment - Skill Under Development					34	
JV Global	Darshan H V	B.E, Mech	6 Years	Quantitative & Analytical	4+3=7	AVG Score - 314 = 7.75 (Offline) = 25 Student/Hr + GST
	Bhargav A P	BA, MA	10 Years	Soft skills	4+4=8	
	Bhomi N	B.Sc, PG, MS, PGDDBA	18 Years	Pre Placement Topics	4+3=9	
Bhomi S	BE, Mech	6 Years	Quantitative & Analytical	4+3=7	31	
Peragon Space	Vaishnavi R.R	BBM, MBA	6 Years	Verbal and communication skills	3+3=6	AVG Score - 304 = 7.50 (Offline) = 32 Student/Hr + GST
	Bhomi E	BE, M.Tech	08 Years	Technical Trainer	4+4=8	
	DAASHIRATHI MESAL	B.Com, MA	15 Years	Soft skills and english	3+5=8	
	ARCHANA H V	B.Com, MBA	13 Years	Soft skills	3+5=8	
					30	

MBA (I & II year)  
19+0.5%

(KSIIT + KSEM)

VII Semster

20+0.5% 15%

KGS  
MTR

Call the above for negotiations.

2/10/22  
6/10/22

checked:  
20/10/22





# K.S INSTITUTE OF TECHNOLOGY

#14, Raghuvanahalli, Kanakapura Main Road, Bengaluru - 560109

Phone: 080-28435722/24 website: www.ksit.ac.in

## \*\* DEPARTMENT OF TRAINING AND PLACEMENTS \*\*

15.11.2022

### PERSONALITY DEVELOPMENT TRAINING PROGRAM FOR THIRD YEAR STUDENTS - 2024 BATCH

Placement department has planned to conduct **Personality Development Training Program** for 5<sup>th</sup> Semester students (All branches) from 17<sup>th</sup> to 23<sup>rd</sup> November 2022. All HOD's are hereby informed to communicate their third year students regarding the same.

The training will be conducted in **old building class rooms**. Batch wise details are shared below. All **placement coordinators** are requested to submit the consolidated attendance of all 5 days to placement department on or before **24<sup>th</sup> November 2022** without fail.

Department wise scheduled is given below for your reference.

Date	Time	BATCH 1	BATCH 2	BATCH 3	BATCH 4	BATCH 5
		CSE (A)	CSE (B)	ECE (A)	ECE (B)	AIML+ME
17 <sup>th</sup> , 18 <sup>th</sup> , 21 <sup>st</sup> , 22 <sup>nd</sup> & 23 <sup>rd</sup> November 2022	8:50 AM – 11:00AM	OB - 007	OB - 008	OB - 104	OB - 105	OB - 106
	11:00AM – 11:15AM	BREAK				
	11:15 AM – 1:15PM	OB - 007	OB - 008	OB - 104	OB - 105	OB - 106
	1:15PM – 1:50PM	LUNCH BREAK				
	1.50PM – 4:00PM	OB - 007	OB - 008	OB - 104	OB - 105	OB - 106

#### NOTE:

1. All students are informed to attend the training compulsory.
2. Minimum attendance should be 85% failing which, students are not allowed for campus drives.
3. Placement dress code compulsory (White formal shirt & Black pant). Jeans are not allowed.
4. Students are strictly informed to be present in their allocated rooms only for all days.



*Shruthi*  
PRINCIPAL  
PRINCIPAL  
K.S. INSTITUTE OF TECHNOLOGY  
BENGALURU - 560 109.

CC TO:

HODs and Coordinators of:

CSE	ECE	AIML	ME
-----	-----	------	----





# K.S INSTITUTE OF TECHNOLOGY

No.14, Raghuvanahalli, Kanakapura Main Road, Bengaluru - 560109

Phone: 080-28435722/24 website: [www.ksit.ac.in](http://www.ksit.ac.in)

## \*\* DEPARTMENT OF TRAINING AND PLACEMENTS \*\*

Date: 16/11/2022

### CIRCULAR

As you are aware, Personality Development Training Program for 5<sup>th</sup> semester students (all branches) is scheduled from 17/11/2022 to 23/11/2022. Placement department has planned to conduct **pre-assessment test** on 16/11/2022 at Bizotic Platform between 5:00PM – 7:00PM. HODs and Coordinators of all the departments are requested to communicate to their pre-final year students accordingly.

The stepwise instructions for the registration process and steps to take the test are as follows:

#### Step 1: Registration Process:

(Please Note: If students have already registered, then please proceed to Step 2)

1. Go to the URL - [ksit.bizoticedtech.com/signup](http://ksit.bizoticedtech.com/signup)
2. Email: Enter your **correct** email id.
3. Password: Set a password for your account.
4. Click on the button 'Sign Up'
5. In the next screen, enter your complete details such as: Full Name, Mobile Number, USN Number, Branch and Year of passing out (Please select your year of passing out as 2024).
6. Once you enter all the details, click on save. It will take you to the test screen.
7. Click on the bundle named "KSIT\_2024 BATCH".
8. Click on the tab 'ENROLL FOR FREE'
9. Click on the test series > Benchmarking> Benchmarking Test 1 > Take test.
10. Read the instructions and start the test.

#### Step 2: Login Process for Registered Students:

(Please Note: If students have not registered in the portal then please refer Step 1)

1. Go to the URL - [ksit.bizoticedtech.com/signin](http://ksit.bizoticedtech.com/signin)
2. Email: Enter your **registered** email id.
3. Password: Enter your password
4. Click on the button 'Sign In'
5. If you have forgotten your password, then you can reset the password using the 'Forgot Password' tab.
6. Click on the test series > Benchmarking> Benchmarking Test 1 > Take test.

#### Test Details:

1. The test is for 60 minutes.
2. You will have 3 sections:
  - A. Quantitative Aptitude - 20 Questions - 25 Minutes
  - B. Logical Reasoning - 15 Questions - 20 Minutes
  - C. Verbal Ability - 15 Questions - 15 Minutes



*Shruthi*

PRINCIPAL

PRINCIPAL  
K.S. INSTITUTE OF TECHNOLOGY  
BENGALURU - 560 109.

CC to:

HODs and Coordinators of:

CSE	<i>Y</i>	ECE	<i>GA</i>	AIML	<i>Gov</i>	MECH	<i>RCU</i>
-----	----------	-----	-----------	------	------------	------	------------





# K.S INSTITUTE OF TECHNOLOGY

No.14, Raghuvanahalli, Kanakapura Main Road, Bengaluru – 560109

Phone: 080-28435722/24 website: [www.ksit.ac.in](http://www.ksit.ac.in)

## \*\* DEPARTMENT OF TRAINING AND PLACEMENTS \*\*

Date: 26/11/2022

### CIRCULAR

This is to inform you that placement department has planned to conduct **post-assessment test** on **26/11/2022** for 5<sup>th</sup> semester B.E students at Bizotic Platform between **5:00PM – 9:00PM**. HODs and Coordinators of all the departments are requested to communicate to their pre-final year students accordingly.

The stepwise instructions for the registration process and steps to take the test are as follows;

The stepwise instructions for the registration process and steps to take the tests are as follows:

#### Step 1: Registration Process:

(Please Note: If students have already registered, then please proceed to Step 2)

1. Go to the URL - [ksit.bizoticedtech.com/signup](http://ksit.bizoticedtech.com/signup)
2. Email: Enter your **correct** email id.
3. Password: Set a password for your account.
4. Click on the button 'Sign Up'
5. In the next screen, enter your complete details such as: Full Name, Mobile Number, USN Number, Branch and Year of passing out (Please select your year of passing out as 2024).
6. Once you enter all the details, click on save. It will take you to the test screen.
7. Click on the bundle named "KSIT\_2024 BATCH".
8. Click on the tab 'ENROLL FOR FREE'.
9. Click on the test series > **Benchmarking**> **Benchmarking Test 2** > Take test.
10. Read the instructions and start the test.

#### Step 2: Login Process for Registered Students:

(Please Note: If students have not registered in the portal then please refer Step 1)

1. Go to the URL - [ksit.bizoticedtech.com/signin](http://ksit.bizoticedtech.com/signin)
2. Email: Enter your **registered email id**.
3. Password: Enter your password
4. Click on the button 'Sign In'
5. If you have forgotten your password, then you can reset the password using the 'Forgot Password' tab.
6. Click on the test series > **Benchmarking**> **Benchmarking Test 2** > Take test.

#### Test Details:

1. The test is for 60 minutes.
2. You will have 3 sections:
  - A. Quantitative Aptitude - 20 Questions - 25 Minutes
  - B. Logical Reasoning - 15 Questions - 20 Minutes
  - C. Verbal Ability - 15 Questions -15 Minutes
3. After you finish a section, you are required to click on the submit button. Once done, the system will take you to the next section. Your test will not be captured If you fail to click on the submit button.
4. Follow this process for all the 3 sections.
5. Click on the tab continue learning > and click **view result** > You will be able to see the detailed test report.

If you face any issues in accessing your account or while taking the test, then please drop in a mail from your registered mail id to [info@bizoticalent.com](mailto:info@bizoticalent.com) with your complete details such as **Name, USN number, College, Email ID** and **Mobile number** with a brief about the issue faced.



*Shamshir*  
PRINCIPAL

PRINCIPAL  
K.S. INSTITUTE OF TECHNOLOGY  
BENGALURU - 560 109.

CC to:





# K.S INSTITUTE OF TECHNOLOGY

CONSOLIDATED ATTENDANCE FOR PDTP\_5th Sem

COMPUTER SCIENCE AND ENGINEERING - OB 007

III YEAR			V SEMESTER									'A' SECTION						
S. No	USN	NAME OF THE STUDENT	Dates															TOTAL
			17/11/2022			18/11/2022			21/11/2022			22/11/2022			23/11/2022			
			1	2	3	4	5	6	7	8	9	10	11	12	13	14	15	
1	1KS20CS001	A AKASH	P	P	A	P	P	A	P	P	A	P	P	A	A	P	A	09
2	1KS20CS002	AAQIB BASHIR	P	P	P	P	P	A	P	P	A	P	P	A	P	A	A	10
3	1KS20CS003	ANAND V S	A	A	A	A	A	A	A	A	A	A	A	A	A	A	A	00
4	1KS20CS004	ANANYA PATIL	A	P	P	P	P	P	A	P	P	A	P	P	A	P	A	10
5	1KS20CS005	ANIRUDHA.K.K	P	P	A	P	P	A	P	P	P	A	A	A	P	A	A	08
6	1KS20CS006	ANKITA CHOUDHARY	P	P	P	P	P	P	A	P	A	P	A	A	A	A	A	08
7	1KS20CS007	ANUPRIYA C	P	P	P	P	A	P	A	A	A	P	P	A	P	A	A	08
8	1KS20CS008	ANUSHREE G M	P	P	P	P	P	P	P	P	P	P	P	P	P	P	P	15
9	1KS20CS009	ANUSHREE H	P	P	P	P	P	A	P	P	P	A	P	A	A	A	A	09
10	1KS20CS010	APEKSHA M	P	P	P	P	P	P	P	P	A	P	P	A	A	A	A	10
11	1KS20CS011	ARCHIT GANAPATI AVADHANI	P	P	P	P	P	P	P	P	A	P	P	A	P	A	A	11
12	1KS20CS012	B JAIDEV	P	P	P	P	P	A	P	P	A	P	P	A	P	A	A	10
13	1KS20CS013	BASAVESH V L	P	P	P	P	P	P	P	P	A	P	P	A	P	A	A	11
14	1KS20CS014	BHUMIKA MAHADEVAPPA UMACHAGI	P	P	P	P	P	A	A	A	A	A	A	A	A	A	A	05
15	1KS20CS015	BHUVAN N GOWDA	P	P	P	P	P	P	P	P	P	P	P	A	P	A	A	12
16	1KS20CS016	BOMMINENI TEJASWINI	P	P	P	P	P	P	P	P	P	P	P	A	P	A	A	12
17	1KS20CS017	BRUNDA B	P	P	P	P	P	P	P	P	A	P	P	P	P	P	P	14
18	1KS20CS018	CHAITRA R	A	P	P	P	P	P	P	P	A	A	P	A	A	A	A	08
19	1KS20CS019	CHEZHAN S	P	P	P	P	P	P	P	P	A	A	A	A	P	A	A	09
20	1KS20CS020	DARSHAN M S	P	P	P	P	P	A	P	P	A	A	A	A	A	A	A	07
21	1KS20CS021	DHANUSH Y	P	P	A	A	P	A	A	P	P	A	A	A	P	P	A	07
22	1KS20CS022	DHANVIN C BHARGAV	P	P	P	P	P	P	P	P	P	P	P	A	P	P	A	13
23	1KS20CS023	DHANYA SHARANYA SHREE R	P	P	P	P	P	P	P	P	P	P	P	P	P	A	A	13
24	1KS20CS024	DIVAKAR M	A	P	A	A	A	A	P	A	P	P	A	A	A	A	A	04
25	1KS20CS025	DIVYA VEERAYYA CHIKKAMATH	A	P	P	P	P	P	P	P	A	P	P	P	P	A	A	11
26	1KS20CS026	EDUMUDI ABHINAYA	P	P	A	A	A	A	P	P	P	P	P	P	P	P	A	10
27	1KS20CS027	G SANJANA RAJU	P	P	P	P	A	P	A	A	A	P	A	A	P	P	A	07
28	1KS20CS028	GAGANA C L NAIK	P	P	P	P	P	A	A	P	P	P	P	A	P	P	P	12
29	1KS20CS029	GAGANA R	P	P	P	P	P	P	P	P	P	P	P	P	P	P	P	15
30	1KS20CS030	GANASHREE G M	P	P	P	P	P	P	P	P	P	A	A	A	P	P	P	12
31	1KS20CS031	GANASHREE K	P	P	P	P	P	P	P	P	A	P	P	P	P	P	P	14
32	1KS20CS032	GIRISH G	P	P	P	P	P	A	P	P	A	P	P	A	P	A	A	10
33	1KS20CS033	GOEL ANANYA DEVENDRA	P	P	P	A	P	P	P	P	A	A	P	P	A	A	A	09
34	1KS20CS034	GURU KASHYAP N S	A	A	A	A	A	A	A	H	P	A	P	A	A	P	A	03
35	1KS20CS035	GURU KIRAN S	P	P	P	P	P	P	P	P	P	P	A	A	P	P	A	12
36	1KS20CS036	H A SANKEERTHAN	P	P	A	P	P	P	P	P	P	A	A	A	A	A	A	08
37	1KS20CS037	H A TRISHALA	P	P	P	A	A	A	A	A	A	A	A	A	A	A	A	03
38	1KS20CS038	HARSHITHA B R	P	P	A	P	P	P	P	P	A	A	A	A	P	A	A	08
39	1KS20CS039	HONOKSHARATHNA B	A	A	A	P	P	P	P	A	A	P	P	A	A	A	A	06
40	1KS20CS040	HRITHIKA.S	P	P	A	A	A	A	A	P	A	A	A	A	A	A	A	03
41	1KS20CS041	JAHNAVI P	A	P	P	A	P	P	A	P	P	A	P	P	A	P	A	09
42	1KS20CS042	JEEVAN	P	P	P	P	P	P	P	P	P	P	P	P	A	A	A	012



Computer - 'A'

43	1KS20CS043	JNANESH A S	A	P	P	A	P	A	A	P	P	P	A	A	A	P	A	07
44	1KS20CS044	JONNA DILEEP	P	P	P	P	P	A	P	P	A	P	P	A	P	A	A	10
45	1KS20CS045	KAVITHA R	P	P	P	P	P	P	P	A	P	P	P	A	A	A	11	
46	1KS20CS046	KAVYA R	P	P	P	P	P	P	P	A	P	P	P	A	A	A	11	
47	1KS20CS047	KUSHAL.K	A	P	P	A	P	A	A	P	P	A	A	A	P	A	07	
48	1KS20CS048	LISHA NIDHI A M	A	P	P	P	P	P	P	A	A	A	A	P	A	A	07	
49	1KS20CS049	M SANTOSHKUMAR M HAMPANNA	P	P	P	P	P	A	P	P	A	P	P	A	A	A	09	
50	1KS20CS050	MAHIM SUBHASH AKHAWAT	P	P	P	A	A	A	A	P	P	A	P	P	P	P	10	
51	1KS20CS051	MANDARA K S	P	P	P	P	P	P	P	P	P	P	P	P	P	A	14	
52	1KS20CS052	MANISH PIKHAN	A	A	A	P	P	A	A	P	A	A	A	A	A	A	03	
53	1KS20CS053	MANISHA G N	P	P	P	P	P	P	P	P	A	P	P	P	A	A	11	
54	1KS20CS054	MANJUNATH R	P	P	P	P	P	A	P	P	P	A	P	A	A	A	09	
55	1KS20CS055	MONICA C S	P	P	P	P	P	P	P	P	P	P	P	A	P	A	12	
56	1KS20CS056	MONIESH.S	A	P	A	A	A	A	A	A	A	A	P	A	A	A	02	
57	1KS20CS057	MONIKA N	P	P	P	P	P	P	P	A	P	P	P	A	A	A	11	
58	1KS21CS401	PAVITHRA A S	A	A	A	A	A	A	A	A	A	A	A	A	A	A	00	
59	1KS21CS402	S POORNACHANDRA	P	P	P	P	P	P	P	P	P	P	P	A	P	A	12	
60	1KS21CS403	SANJEEV KULKARNI	A	A	A	P	P	P	P	P	A	P	P	A	P	A	08	
61	1KS21CS404	SANTOSH N	A	A	A	A	A	A	A	A	A	A	A	A	P	A	08	
62	1KS21CS405	SUHAS R	A	A	A	P	P	P	P	P	A	P	P	A	P	A	08	
63	1KS21CS406	VAISHNAVI S SHARMA	A	A	A	P	P	P	P	P	A	P	P	A	A	A	07	
64	1KS21CS407	VIDHYA J	P	P	P	P	P	P	P	P	A	P	P	A	P	A	11	
No. of Students Absent			18	08	18	15	12	26	19	11	27	24	20	18	31	45	57	02
No. of Students Present			46	56	46	49	52	38	45	53	27	40	44	18	33	19	7	62
Signature of trainer/placement coordinator			<i>[Signature]</i>	<i>[Signature]</i>	<i>[Signature]</i>	<i>[Signature]</i>	<i>[Signature]</i>	<i>[Signature]</i>	<i>[Signature]</i>	<i>[Signature]</i>	<i>[Signature]</i>	<i>[Signature]</i>	<i>[Signature]</i>	<i>[Signature]</i>	<i>[Signature]</i>	<i>[Signature]</i>	<i>[Signature]</i>	<i>[Signature]</i>



6174





# K.S INSTITUTE OF TECHNOLOGY

CONSOLIDATED ATTENDANCE FOR PDTP\_5th Sem

COMPUTER SCIENCE AND ENGINEERING - OB 008

(Shameen)

III YEAR			V SEMESTER									'B' SECTION						
S. No	USN	NAME OF THE STUDENT	Dates															TOTAL
			17/11/2022			18/11/2022			21/11/2022			22/11/2022			23/11/2022			
			1	2	3	4	5	6	7	8	9	10	11	12	13	14	15	
1	1KS20CS058	N KEERTHANA	P	P	P	P	P	P	P	P	P	P	P	P	P	P	P	14
2	1KS20CS059	NAJEEB MUTHAHEED ARIN UL HAQ	P	P	AB	P	AB	AB	A	A	A	A	A	A	A	A	A	03
3	1KS20CS060	NAMRATHA R	P	P	AB	A	P	AB	P	P	A	A	A	A	A	A	A	05
4	1KS20CS061	NARASIMHA N	P	P	P	P	P	P	P	P	P	A	A	P	P	A	A	12
5	1KS20CS062	NEHA REDDY S	P	P	P	P	P	P	A	A	A	P	P	A	P	P	A	10
6	1KS20CS063	NIDHI K V	P	P	P	P	P	P	A	P	A	P	A	A	P	P	A	10
7	1KS20CS064	NIRMITHA N	P	P	P	P	P	P	P	A	A	P	P	P	P	P	A	12
8	1KS20CS065	N NITHESH KUMAR	P	P	AB	A	AB	AB	P	AP	A	P	A	A	A	A	A	05
9	1KS20CS066	NUTHANAPATI DEVITHA	AB	AB	AB	A	AB	AB	A	A	A	A	A	A	A	A	A	00
10	1KS20CS067	PARVASHREE H M	P	P	P	P	P	P	A	A	P	P	P	P	P	A	A	12
11	1KS20CS068	PARVATHY P S	AB	AB	AB	P	P	AB	P	A	A	P	P	A	P	P	A	07
12	1KS20CS069	PAVAN C	AB	AB	AB	A	AB	AB	A	A	A	A	A	A	A	A	A	00
13	1KS20CS070	PAVAN KUMAR S	AB	AB	AB	A	AB	AB	A	A	A	A	A	A	A	A	A	00
14	1KS20CS071	PAVAN M	P	P	P	P	P	P	P	P	A	P	P	A	P	A	A	11
15	1KS20CS072	PAVAN P	P	P	P	P	P	P	P	P	A	P	P	A	P	A	A	11
16	1KS20CS073	PAVITHRA R	P	P	P	P	P	P	P	A	A	P	P	P	P	P	A	12
17	1KS20CS074	POOJITHA Y	P	P	P	P	AB	AB	P	P	A	P	P	A	A	A	A	08
18	1KS20CS075	POONAM	P	P	P	P	P	P	P	A	A	P	P	P	P	P	A	12
19	1KS20CS076	PRADHYUMNA K	P	P	AB	P	P	AB	P	P	A	P	A	A	P	P	A	09
20	1KS20CS077	PRAJWAL NAIK U	AB	AB	AB	A	AB	AB	A	P	A	A	A	A	A	A	A	01
21	1KS20CS078	R.KUSHAL SAI	P	P	P	P	P	AB	P	P	A	P	A	P	P	A	A	10
22	1KS20CS079	RAGHAVI C S	P	P	P	P	P	P	A	A	A	A	A	A	P	P	A	08
23	1KS20CS080	RAKSHITH.C MAHALADKAR	P	P	AB	A	P	P	A	P	A	A	A	A	P	P	A	07
24	1KS20CS081	RAKSHITHA P	P	P	P	P	P	AB	P	A	A	P	P	A	P	P	A	10
25	1KS20CS082	ROSHAN KUMAR.B	AB	AB	AB	A	AB	AB	A	A	A	A	A	A	A	A	A	00
26	1KS20CS083	S.SAI SHANKARI	AB	AB	AB	P	P	AB	A	A	A	A	A	A	A	A	A	02
27	1KS20CS084	SAAHIL BHUJANG DHARMAJI	AB	AB	AB	P	P	AB	P	P	P	P	A	A	P	P	P	09
28	1KS20CS085	SABHAREESH BALAJI P	AB	P	AB	P	AB	AB	A	P	A	A	A	A	A	A	A	02
29	1KS20CS086	SAHANA R	P	P	P	P	P	P	P	P	P	P	P	P	P	P	A	14
30	1KS20CS087	SAMEER KULKARNI	AB	AB	AB	P	AB	AB	P	P	A	A	A	A	A	A	A	03
31	1KS20CS088	SANKET GANAPATI HEGDE	P	P	AB	P	P	AB	P	P	A	P	P	A	A	A	A	08
32	1KS20CS089	SHASHIKANTH N G	AB	P	AB	P	AB	AB	A	A	A	P	P	A	A	A	A	04
33	1KS20CS090	SHASHWATHA H M	AB	P	P	P	P	P	A	P	P	P	P	A	A	A	A	09
34	1KS20CS091	SHILPA M	P	P	P	P	P	P	P	P	P	P	P	P	P	P	P	15
35	1KS20CS092	SHRAVYA M R	P	P	P	P	P	P	P	P	A	P	P	A	P	P	A	012
36	1KS20CS093	SINDHURA H	P	P	P	P	P	P	P	A	A	P	P	P	P	P	P	13
37	1KS20CS094	SIRIPIREDDY THULASI	AB	AB	P	P	AB	AB	P	P	A	P	P	A	A	A	A	06
38	1KS20CS095	SKANDA SWAROOPA B V	AB	AB	AB	A	AB	AB	A	A	A	A	A	A	A	A	A	00
39	1KS20CS096	SPOORTHY.N	AB	P	P	P	P	P	A	P	P	P	P	A	A	A	A	09
40	1KS20CS097	SRISHTI SRIVASTAVA	AB	P	P	P	P	P	P	A	A	P	P	P	P	P	A	11
41	1KS20CS098	SUDEEP D M	AB	AB	AB	P	AB	AB	P	P	A	A	A	A	A	A	A	03
42	1KS20CS099	SUSHMA SRIKANTA KURANDWAD	P	P	P	P	P	AB	A	A	A	P	P	P	A	A	A	07



43	1KS20CS100	TAHREEM IMAD PASHA	AB	AB	AB	A	AB	AB	A	A	A	A	A	A	A	A	A	A	00
44	1KS20CS101	TALIB MUKHTAR CHODA	P	P	P	P	P	AB	P	P	A	P	A	P	P	A	A	A	10
45	1KS20CS102	TANVI KAMATH	P	P	AB	P	AB	AB	P	A	A	P	P	A	P	A	A	A	07
46	1KS20CS103	THANUSHA K	P	P	P	P	P	P	P	A	A	P	P	P	A	A	A	A	10
47	1KS20CS104	TRUPTHI G B	P	P	P	P	P	P	A	A	A	P	P	A	A	A	A	A	08
48	1KS20CS105	TUSHAR S	P	P	P	P	P	P	A	P	A	P	P	A	P	A	A	A	010
49	1KS20CS106	V ARVIND	P	P	AB	A	AB	AB	A	A	A	P	P	A	A	A	A	A	04
50	1KS20CS107	VAISHNAVI M	P	P	P	P	P	AB	P	P	A	P	P	A	P	P	A	A	11
51	1KS20CS108	VANDANA N	AB	AB	P	P	P	P	P	P	P	P	P	P	P	P	P	A	14
52	1KS20CS109	VANDANA N	AB	AB	AB	P	P	AB	A	A	A	P	P	A	A	A	A	P	05
53	1KS20CS110	VIBHAV KAUSHIK V	AB	P	AB	A	P	AB	P	A	A	A	A	A	A	A	A	A	03
54	1KS20CS111	VIKAS KASHYAP R	P	AB	AB	AB	P	P	P	P	A	P	P	A	P	A	A	A	09
55	1KS20CS112	VISHAL N KORABU	P	P	AB	P	P	AB	P	A	A	P	P	A	A	A	A	A	07
56	1KS20CS113	VUMMANENI CHARAN	P	P	AB	P	AB	AB	A	A	A	A	A	A	A	A	A	A	03
57	1KS20CS114	Y JHANSI	AB	AB	AB	P	P	AB	A	A	A	A	A	A	A	A	A	A	03
58	1KS20CS115	MOHAMMAD TAHA	AB	AB	AB	A	AB	AB	A	P	A	A	A	A	A	A	A	A	02
59	1KS20CS116	ASHRIT MADHAV VADIRAJ	AB	P	P	P	P	AB	A	P	P	P	P	A	P	A	A	A	10
60	1KS20CS117	DEEPAK S	AB	P	P	A	P	AB	A	A	P	P	P	A	P	A	A	A	07
61	1KS20CS118	K R SAHANA	P	P	P	P	P	P	A	A	A	P	P	A	P	A	A	A	08
62	1KS20CS119	SNEHA A S	P	P	P	P	P	P	P	P	P	P	P	A	P	P	A	A	13
63	1KS20CS120	AJAY GIRISH	P	P	P	P	P	AB	P	P	P	P	P	A	P	A	A	A	11
64	1KS20CS121	SAKSHAM SINGH	AB	P	P	A	P	AB	A	A	P	A	P	A	P	A	A	A	06
65	1KS20CS122	RAVI VAMSHI D N	P	P	P	P	P	P	A	A	A	A	A	A	A	A	A	A	06
66	1KS20CS123	SANJANA G	P	P	P	P	P	AB	A	A	A	P	A	A	A	A	A	A	06
No. of Students Absent			25	16	29	15	19	39	31	35	53	22	P	52	32	44	56	06	
No. of Students Present			41	50	37	51	47	27	35	31	13	44	38	14	34	22	10	60	
Signature of trainer/placement coordinator			P	P	P	P	P	P	P	P	P	P	P	P	P	P	P	P	02







# K.S INSTITUTE OF TECHNOLOGY

CONSOLIDATED ATTENDANCE FOR PDTP\_5th Sem

ELECTRONICS & COMMUNICATION ENGINEERING - OB 104

III YEAR			V SEMESTER								'A' SECTION								
S.No	USN	NAME OF THE STUDENT	Dates															TOTAL	
			17/11/2022			18/11/2022			21/11/2022			22/11/2022			23/11/2022				
			1	2	3	4	5	6	7	8	9	10	11	12	13	14	15		
1	1KS19EC026	ERAM FATHIMA	A	A	A	I	I	P	P	A	A	A	A	A	A	A	A	A	04
2	1KS19EC034	HIMA SWETHA S	1	1	I	I	I	A	P	P	A	P	P	P	P	A	A	A	11
3	1KS20EC001	ABHISHEK J	1	1	I	I	I	P	A	P	A	P	P	P	P	P	A	A	12
4	1KS20EC002	Aditi dubey	1	1	I	I	I	P	P	P	P	P	P	A	P	P	P	A	14
5	1KS20EC003	AFFEEFA SHARIEFF	1	1	I	I	I	P	P	P	P	P	P	A	P	P	P	A	14
6	1KS20EC004	Ajay B G	1	1	I	I	I	P	P	P	P	A	P	P	P	P	P	A	14
7	1KS20EC006	Akash M	AB	AB	AB	AB	I	P	A	P	A	A	P	6P	A	P	A	A	06
8	1KS20EC008	B.S.HEMASHREE	1	1	I	I	I	P	P	P	P	P	P	P	P	P	P	A	14
9	1KS20EC009	BHARATH M	1	1	I	I	I	P	P	P	P	P	A	A	P	A	A	A	11
10	1KS20EC010	Bhavitha. B	1	1	I	I	I	P	P	P	A	P	P	A	P	P	P	A	13
11	1KS20EC011	Bhuvaneshwari k	1	1	I	I	I	P	P	P	AP	P	P	P	P	P	P	A	15
12	1KS20EC012	Chaitanya k	1	1	I	I	I	P	P	P	P	P	P	A	P	A	P	A	13
13	1KS20EC013	CHAITHRA K	1	1	I	AB	A	A	P	P	P	P	P	P	A	A	A	A	09
14	1KS20EC014	C. Sai Srujitha	1	1	I	I	I	P	A	A	A	A	A	A	P	A	A	A	07
15	1KS20EC015	C.Umadevi	1	1	I	10	I	P	P	P	P	A	A	A	A	P	A	A	10
16	1KS20EC016	Chaya. S	1	1	I	I	I	P	P	P	P	P	P	P	P	P	P	A	15
17	1KS20EC017	Chethan G	1	1	I	I	I	P	P	P	A	P	P	P	P	P	A	A	13
18	1KS20EC018	Chethankumar J	1	1	AB	I	I	P	P	P	A	P	P	A	P	P	A	A	11
19	1KS20EC019	CHEZHAN KUMAR T	1	1	I	I	I	P	P	P	A	P	A	P	P	P	A	A	12
20	1KS20EC020	DARSHAN K	1	1	I	AB	A	A	P	P	A	P	P	A	P	A	P	A	09
21	1KS20EC021	DARSHAN KUMAR S	1	1	I	I	I	P	P	P	P	P	P	P	A	P	P	A	14
22	1KS20EC023	Dhamini. J	1	1	I	I	I	P	P	P	P	P	P	P	P	P	P	A	15
23	1KS20EC024	Dhruva Kumar S	1	1	I	I	I	P	P	P	A	P	P	A	P	P	A	A	12
24	1KS20EC025	Divya .N	1	1	I	I	I	P	P	P	P	P	P	P	P	P	P	A	15
25	1KS20EC026	Eshwar Biradar	1	1	I	I	I	P	P	P	A	P	P	A	A	A	A	A	10
26	1KS20EC027	G BHAVANA PRIYADARSHINI	1	1	I	I	I	P	P	P	P	P	P	P	P	P	P	A	15
27	1KS20EC028	Gagan.H.C	AB	AB	AB	A	I	P	P	P	P	P	P	A	P	P	P	A	11
28	1KS20EC029	Gagana B S	1	1	I	I	I	P	P	P	A	P	A	A	A	A	A	A	09
29	1KS20EC030	Gandhamani C M	1	1	I	I	I	P	P	P	P	P	P	A	P	P	P	A	14
30	1KS20EC031	Gomitha R C	1	1	I	I	I	P	P	A	A	P	P	P	A	A	P	A	14
31	1KS20EC032	Harini k	1	1	I	10	I	P	P	P	P	P	P	A	A	A	A	A	11
32	1KS20EC033	Harshith gowda AR	1	1	I	I	I	P	P	P	P	P	P	P	P	P	P	A	15
33	1KS20EC034	Harshitha. B.L	1	1	I	I	I	P	P	P	P	P	P	P	P	P	P	A	15
34	1KS20EC035	Harshitha.J	1	1	I	I	I	P	P	P	A	P	P	P	P	P	A	A	13
35	1KS20EC036	HARSHITHA N	1	1	I	I	I	P	P	P	P	P	P	P	P	P	P	A	15
36	1KS20EC037	Inchara. P	1	1	I	I	I	P	P	P	A	P	A	A	A	A	A	A	09
37	1KS20EC038	Chalthanya krishna.J	1	1	I	I	I	P	P	P	P	P	P	A	P	A	A	A	12
38	1KS20EC039	Jamuna s g	1	1	I	I	I	P	P	A	A	P	A	P	A	A	A	P	10
39	1KS20EC040	Janhavi r	1	1	I	I	I	P	P	A	A	P	A	P	A	A	P	A	10
40	1KS20EC041	JAYANTH. H	1	1	I	I	I	P	P	P	A	P	P	P	A	P	P	A	13
41	1KS20EC042	K Jeevitha	1	1	I	I	I	P	P	P	P	P	A	A	A	A	A	A	10
42	1KS20EC043	K.M.Amshumanth	1	1	I	I	I	A	A	A	A	P	P	A	A	A	A	A	07



43	1KS20EC045	Kavana.G.S	1	1	1	1	1	P	A	A	A	A	A	A	A	A	06
44	1KS20EC046	Kavya S M	1	1	1	1	1	P	P	P	A	P	P	A	A	A	10
45	1KS20EC047	Keerthana BS	1	1	1	1	1	P	P	P	P	A	A	A	P	A	10
46	1KS20EC048	Kiran Dev D	1	1	1	1	1	P	P	P	A	P	P	A	A	A	10
47	1KS20EC049	KIRAN V NARAYAN	1	1	1	1	1	P	P	A	A	P	P	A	P	P	11
48	1KS20EC050	KODIDELA. PRATHIMA	1	1	1	1	1	P	P	P	P	P	P	A	P	A	12
49	1KS20EC051	KUMAR K G	1	1	1	1	1	P	P	A	P	P	P	A	P	P	12
50	1KS20EC052	Kusuma VR	1	1	1	1	1	A	A	A	A	A	A	A	A	A	10
51	1KS20EC053	M.Archana	1	1	1	1	1	P	P	P	P	P	P	A	P	A	11
52	1KS20EC054	MADIHA	1	1	1	1	1	P	P	P	A	P	P	A	P	P	13
53	1KS20EC055	MAHESH BIRADAR	1	1	1	1	1	P	P	A	A	P	P	A	A	A	09
54	1KS20EC056	MANASWINI KM	1	1	1	1	1	A	A	A	A	A	A	A	A	A	05
55	1KS20EC057	Meghashree.M	1	1	1	1	1	P	P	P	P	P	P	A	P	P	13
56	1KS20EC058	MOHAN KRISHNA K	1	1	1	1	1	A	A	A	A	P	P	A	A	A	05
No. of Students Absent			03	03	04	04	2	2	7	13	30	9	16	34	22	25	33
No. of Students Present			53	53	52	50	54	54	49	43	26	47	40	22	34	31	23
Signature of trainer/placement coordinator			<i>[Signature]</i>	<i>[Signature]</i>	<i>[Signature]</i>	<i>[Signature]</i>	<i>[Signature]</i>	<i>[Signature]</i>	<i>[Signature]</i>	<i>[Signature]</i>	<i>[Signature]</i>	<i>[Signature]</i>	<i>[Signature]</i>	<i>[Signature]</i>	<i>[Signature]</i>	<i>[Signature]</i>	<i>[Signature]</i>



Vertical handwritten text on the left side of the page, possibly a list of names or identifiers.

Vertical handwritten text on the right side of the page, possibly a list of names or identifiers.







43	1KS20EC106	TEJAS N REDDY	P	P	P	P	P	P	P	A	P	A	A	A	P	P	A	10
44	1KS20EC107	T.GIRISHCHOWDARY	P	P	P	A	A	A	A	A	A	A	A	A	A	A	A	03
45	1KS20EC108	Uday C H	P	P	P	P	P	P	P	P	P	P	P	A	P	P	P	14
46	1KS20EC109	UJJWAL NAIDU	P	P	P	P	P	P	A	A	A	A	A	A	A	A	A	06
47	1KS20EC110	VAISHNAVI A	P	P	P	P	P	P	P	A	A	P	A	A	A	A	A	08
48	1KS20EC111	Vaishnavi.V.H	P	P	P	P	P	P	P	A	A	P	P	A	A	A	A	09
49	1KS20EC112	N Varsha	P	P	P	P	P	P	P	P	A	A	A	A	P	P	A	10
50	1KS20EC113	Vijayalakshmi K	P	P	P	P	P	P	P	A	A	P	P	A	A	A	A	09
51	1KS20EC114	VINAY S P	P	P	P	P	P	P	A	A	A	P	P	P	P	P	A	11
52	1KS20EC115	VINAY SAGAR V ALUR	P	P	P	P	P	P	P	P	P	P	P	P	P	P	A	14
53	1KS20EC116	VINEETH M S	P	P	P	A	P	P	A	A	A	P	P	P	A	P	A	09
54	1KS20EC117	YASHILAA.S	P	P	P	P	P	P	P	A	A	P	P	A	A	A	A	09
55	1KS20EC118	YASHWANTH Y	P	A	A	P	P	P	A	A	A	P	P	A	P	P	A	08
56	1KS21EC401	SUDEEP V	P	P	P	P	P	A	A	A	P	P	P	A	P	P	P	12
No. of Students Absent			10	8	8	14	9	12	23	29	32	15	29	21	16	47	01	
No. of Students Present			46	48	48	42	47	44	32	29	24	41	41	27	35	40	9	55
Signature of trainer/placement coordinator			B	V	P	S	S	S	S	S	V	V	M	K	A	K	S	S







# K.S INSTITUTE OF TECHNOLOGY

CONSOLIDATED ATTENDANCE FOR PDTP\_5th Sem

**KSIT**

AIML + MECHANICAL ENGINEERING - OB 106

III YEAR			V SEMESTER													TOTAL		
S. No	USN	NAME OF THE STUDENT	Dates															
			17/11/2022			18/11/2022			21/11/2022			22/11/2022			23/11/2022			
			1	2	3	4	5	6	7	8	9	10	11	12	13	14	15	
1	1KS20AI001	ABHISHEK A	P	P	P	P	P	P	P	A	A	P	P	P	A	P	A	11
2	1KS20AI002	AMITH MAIYA.G	P	P	P	P	P	P	P	P	P	P	P	P	P	P	P	15
3	1KS20AI003	ANANYA .P.	A	A	A	A	A	A	A	A	A	A	A	P	A	P	P	03
4	1KS20AI004	ANUSHA PHANIRAJ	P	P	P	P	A	P	P	A	A	A	A	P	A	P		09
5	1KS20AI005	BHAVANASHREE.K.S	P	P	P	P	P	P	A	A	A	P	P	P	P	P	A	11
6	1KS20AI006	C.M.RITHIKA	P	P	P	P	P	P	P	P	P	P	P	P	P	A	A	13
7	1KS20AI007	CHANDAN.V.K	P	P	P	P	P	P	P	P	P	A	A	A	A	P	P	11
8	1KS20AI008	CHETAN VEERANA GOUDA MUDIGOUDRA	P	P	P	P	P	P	P	P	P	P	P	P	P	P	P	15
9	1KS20AI009	DHANUSH.P	A	A	A	P	P	P	P	P	P	P	P	P	P	P	A	11
10	1KS20AI010	DHARMAVARAPU LAKSHMI AARADHYA	P	P	P	P	P	A	P	P	A	A	A	P	P	A		10
11	1KS20AI011	DISHA GUPTA	A	A	A	P	P	P	P	P	A	P	P	P	P	A	A	09
12	1KS20AI012	GURUDEEP.R	A	A	A	A	A	A	A	A	A	P	P	P	P	P	P	06
13	1KS20AI014	KANDRA AKASH	P	P	P	P	A	P	P	P	P	P	P	P	A	P	A	12
14	1KS20AI015	KARTIK BHATT	A	A	P	P	P	A	P	P	A	P	P	P	P	P	P	11
15	1KS20AI016	LASYA BABU K.M.	P	P	P	P	P	P	P	P	P	P	P	P	P	A	A	13
16	1KS20AI017	LIKHITH.V	A	P	P	P	P	A	A	A	A	P	P	P	A	P	P	09
17	1KS20AI018	LITHEESH V.R.	P	P	P	P	P	P	P	P	P	A	A	A	A	P	A	10
18	1KS20AI019	LOKESH .N.	P	P	A	P	P	P	P	P	P	P	P	A	P	P	A	012
19	1KS20AI020	M. DIVYASHREE	P	P	P	P	A	P	P	P	A	P	P	P	A	P	A	11
20	1KS20AI021	M.V. VARUN	P	P	P	P	P	P	P	P	A	P	P	P	P	P	P	14
21	1KS20AI022	MADHU S. SALIMATH	P	P	P	P	P	P	P	P	P	P	P	P	P	P	A	14
22	1KS20AI023	MEDI VINAY	P	P	P	P	P	P	P	P	P	A	A	A	A	P	A	10
23	1KS20AI025	MONISH.M	A	P	P	P	P	A	P	P	A	P	P	P	A	P	P	11
24	1KS20AI026	NETHRANAND P.S.	P	P	P	P	P	P	P	P	P	P	P	A	P	P	A	13
25	1KS20AI027	NIRIKSHA.D	P	P	P	P	A	P	P	P	P	P	P	P	P	P	A	13
26	1KS20AI028	NISHITHA.S.	P	A	A	A	A	A	A	A	A	P	P	A	A	A	A	03
27	1KS20AI030	PAVAN KALYAN.N.	A	P	P	P	P	A	P	P	P	P	P	A	A	P	A	11
28	1KS20AI031	POORNIMA.M.C	P	P	P	P	P	A	A	A	A	P	P	P	A	A	A	09
29	1KS20AI032	PRIYANKA.A.H	P	P	P	P	P	A	A	A	A	P	P	P	P	P	A	11
30	1KS20AI033	RAKSHITA.PANDURANG KULKARNI	P	P	P	P	P	A	A	A	A	P	P	P	P	P	A	11
31	1KS20AI034	RUPA RAJASRI PUTHINEEDI	P	P	P	A	A	A	P	P	A	P	A	A	A	A	A	06
32	1KS20AI035	SAGAR .P	P	P	A	P	P	P	P	P	P	P	P	P	P	P	A	13
33	1KS20AI036	SAHITHI BHASHYAM	P	P	P	P	A	P	P	A	A	A	A	P	P	P		10
34	1KS20AI037	SHRUTHI. K	P	P	P	P	P	P	P	P	P	A	A	A	A	P	A	11
35	1KS20AI038	SINDHUJA CHINDIRALA	P	P	P	P	P	P	P	P	P	P	P	P	A	A	P	13
36	1KS20AI039	SNEHA G. PALANKER	P	A	A	A	A	A	P	A	A	P	P	A	A	A	A	04
37	1KS20AI041	TANMAYEE R	P	P	P	P	P	P	P	P	P	P	P	P	A	A	A	12
38	1KS20AI042	TEJASWINI L	P	P	P	P	P	P	P	P	P	A	A	A	P	P	P	12
39	1KS20AI043	V.PREETHI	A	P	P	P	P	P	P	P	P	A	A	A	A	P	A	10
40	1KS20AI044	VIPUL KANT TRIPATHI	P	P	P	P	P	P	P	P	A	P	P	P	P	P	A	4
41	1KS20AI046	YASHILA.R	P	P	P	P	P	P	P	P	P	P	P	P	A	A	A	12



42	1KS20AI047	YOGITHA .S.	A	A	A	A	A	A	A	A	A	A	A	A	A	A	(00)	
43	1KS20ME001	DARSHAN S	A	A	A	A	A	A	A	P	P	P	P	A	A	A	04	
44	1KS20ME002	HARSHAVARDHAN.V	A	A	A	A	A	P	P	P	P	P	P	P	P	A	08	
45	1KS20ME003	HARYANK V KASHYAP	A	P	P	P	P	P	P	P	P	P	P	P	P	A	13	
46	1KS20ME004	KUSHAL KADAM	A	A	A	A	A	P	P	P	P	P	P	A	A	A	06	
47	1KS20ME005	PRANITHA.R	1	P	P	A	A	A	P	P	P	A	A	A	A	A	05	
48	1KS20ME006	SHALINI D S	A	A	A	A	A	A	A	A	A	A	A	A	A	A	(00)	
49	1KS20ME007	SHREYAS.S.K	1	P	P	P	P	P	P	P	P	P	P	A	A	P	13	
50	1KS20ME008	SUPRITH GOWDA J	A	A	A	A	A	P	P	P	P	P	P	A	A	A	06	
51	1KS21ME400	PRAVEEN K	A	A	A	A	A	A	A	A	A	A	A	A	A	A	(00)	
52	1KS21ME401	PRERAN GOWDA K	A	A	A	A	A	P	P	P	P	P	P	P	P	A	08	
53	1KS21ME402	VINEETH P	A	A	A	A	A	A	P	A	A	A	A	A	A	A	01	
54	1KS19ME031	SHREYAS H VASIST	A	A	A	A	A	A	A	A	P	P	P	A	A	A	03	
55	1KS18ME421	MADHU KIRAN H	A	A	A	P	A	A	P	P	P	P	P	A	A	A	08	
No. of Students Absent			19	18	19	16	17	15	16	15	23	16	17	20	29	23	43	(63)
No. of Students Present			36	37	36	39	38	30	39	41	23	40	39	36	26	32	12	(52)
Signature of trainer/placement coordinator			Ve	B	B	Ve	V	S	S	P	P	Ve	VM	S	S	V	VM	-B

g) 1KS19ME012 Chudumth.



42	1KS20AI047	YOGITHA .S.	A	A	A	A	A	A	A	A	A	A	A	A	A	A	(00)	
43	1KS20ME001	DARSHAN S	A	A	A	A	A	A	A	P	P	P	P	A	A	A	04	
44	1KS20ME002	HARSHAVARDHAN.V	A	A	A	A	A	P	P	P	P	P	P	P	P	A	08	
45	1KS20ME003	HARYANK V KASHYAP	A	P	P	P	P	P	P	P	P	P	P	P	P	A	13	
46	1KS20ME004	KUSHAL KADAM	A	A	A	A	A	P	P	P	P	P	P	A	A	A	06	
47	1KS20ME005	PRANITHA.R	1	P	P	A	A	A	P	P	P	A	A	A	A	A	05	
48	1KS20ME006	SHALINI D S	A	A	A	A	A	A	A	A	A	A	A	A	A	A	(00)	
49	1KS20ME007	SHREYAS.S.K	1	P	P	P	P	P	P	P	P	P	P	A	A	P	13	
50	1KS20ME008	SUPRITH GOWDA J	A	A	A	A	A	P	P	P	P	P	P	A	A	A	06	
51	1KS21ME400	PRAVEEN K	A	A	A	A	A	A	A	A	A	A	A	A	A	A	(00)	
52	1KS21ME401	PRERAN GOWDA K	A	A	A	A	A	P	P	P	P	P	P	P	P	A	08	
53	1KS21ME402	VINEETH P	A	A	A	A	A	A	P	A	A	A	A	A	A	A	01	
54	1KS19ME031	SHREYAS H VASIST	A	A	A	A	A	A	A	A	P	P	P	A	A	A	03	
55	1KS18ME421	MADHU KIRAN H	A	A	A	P	A	A	P	P	P	P	P	A	A	A	08	
No. of Students Absent			19	18	19	16	17	15	16	15	23	16	17	20	29	23	43	(63)
No. of Students Present			36	37	36	39	38	30	39	41	23	40	39	36	26	32	12	(52)
Signature of trainer/placement coordinator			Ve	B	B	Ve	V	S	S	P	P	Ve	VM	S	S	V	VM	-B



5144873  
22.07.2022  
CTS - 2010  
SESHAASAI (M)

**AXIS BANK LTD**  
JPNAGAR, 6TH PHASE, BANAGLORE (K, BENGALURU, 560078)  
IFS CODE - UTIB0001513

**A/c. PAYEE ONLY**

VALID FOR THREE MONTHS FROM THE DATE OF ISSUE

DATE **25/11/2022**  
दिनांक D D M M Y Y Y Y

Pay **Universal Education**

OR BEARER / या धारक को

रुपये Rupees **One lakh fifty nine thousand  
nine hundred thirty eight only**

अदा करें ₹ **1,59,938/-**

AC NO. **912010014093916**

For K S INSTITUTE OF TECHNOLOGY

PLTRS 000160

*[Signature]*  
Authorised Signatory(ies)  
Please sign above

Payable at par at all branches of Axis Bank Ltd in India.

⑈ 224464 ⑈ 560211034⑈ 000160 ⑈ 31

*Revised cheque  
k. Ravi Rai*





**KSIT**

Kammavari Sangham (R) 1952  
K.S. GROUP OF INSTITUTIONS

ಕೆ.ಎಸ್. ತಾಂತ್ರಿಕ ಮಹಾವಿದ್ಯಾಲಯ

**K.S. INSTITUTE OF TECHNOLOGY**  
Accredited By NAAC

# 14, Raghuvanahalli, Kanakapura Road, Bengaluru - 560 109.

Tel : 080 28435722 / 24, Fax : 080 28435723

E-mail : principal.ksit@gmail.com / principal@ksit.edu.in | website : www.ksit.edu.in

Ref: KSIT/PO/2022-2023/TPO 006

Date: 20/10/2022

To,  
Universal Education  
No. 93, 17<sup>th</sup> Cross, 33<sup>rd</sup> Main, JP Nagar 6<sup>th</sup> Phase, Bangalore - 560078

Dear Sir,

**Sub:** Purchase Order for Personality Development Training Program for Final Year B.E Students.

With reference to the above, we are pleased to place the order for **Personality Development Training Program** for 7<sup>th</sup> Semester Students at K.S. Institute of Technology, #14, Raghuvanahalli, Kanakapura Road, Bangalore – 109 as per the following specifications, terms & conditions.

**Programme Commercials:**

SLNo.	Description	Quantity	Rate	Amount
1	Personality Development Training Program for Final Year B.E Students.	251	Rs. 20/Hour/Student (251 × 30Hrs × 20Rs)	1,50,600/-
	Total			1,50,600/-
	Taxable Value			27,108/-
	ADD: CGST 9%			13,554/-
	ADD: SGST 9%			13,554/-
	<b>Grand TOTAL</b>			<b>1,77,708.00/-</b>

Amount in Words: Rupees One Lakh Seventy Seven Thousand and Seven Hundred Eight Only

**Terms & Conditions:**

- Training for 7<sup>th</sup> Semester students would be from 2<sup>nd</sup> – 8<sup>th</sup> November 2022.
- Pre assessment and post assessment test would be conducted at company's portal only and report to be submitted on or before 14<sup>th</sup> November 2022.
- Full Payment to be made post satisfactory completion of the training.

Thanking you,

Hon. Secretary

KAMMAVARI SANGHAM





**K S GROUP OF INSTITUTIONS**  
**DEPARTMENT OF TRAINING AND PLACEMENTS**

**COMPARATIVE STATEMENT OF TRAINING VENDORS**

Name of Training Agency	Trainer Profile and Rating					Training Cost / Student / Hour
	1 Name	2 Qualification	3 Professional Experience	4 Specialization	5 Rating and Remarks	
AUDAZ	Asgar Pasha	B.Sc MBA HR	18 years	Personality Development	3+5 = 8	AVG Score - 33/4 = 8.25 ✓ (Offline) = 20.5/Student/Hr + GST 17 + 0.25
	Belliapa	B.E. M.Tech	30 year	Soft Skills	4+5 = 9	
	Parvathi	B.A.M.A. MBA HR	18 years	Personality Development	3+5 = 8	
	Kavitha M	B.Sc (Physics, Maths & Electronics) M.sc (Maths) M.A. English	20 years	Aptitude & Soft Skills	3+5 = 8	
Assessment Portal-Own portal available					33	

BIZOTIC	SRINATH SETHURAMAN	M.Sc, MBA (UK)	20 Years	Soft Skills and Verbal	3+5 = 8	AVG Score - 33/4 = 8.25 ✓ (Offline) = 20/Student/Hr + GST 20 + 0.25
	VINEET MANN	B.Sc, M.Sc	15 Years	Aptitude	3+5 = 8	
	SHASHIKALA MADHUSUDHAN	LLB, M.Sc	22 Years	Soft Skills and Verbal	3+5 = 8	
	K KRISHNA BAI	B E, M Tech (BSP)	10 Years	Technical & Aptitude	4+5 = 9	
Assessment- Own Portal Available					33	

Quan Tech Origin	Deepak P.N.	B E, M.E	08 Years	English and Soft skills	3+4 = 7	AVG Score - 25/4 = 6.25 ✓ (Offline) = 20/Student/Hr + GST 20 + 0.25
	SAMUEL JOHN	Diploma (counselling skills), B. A	12 Years	Communication and Soft Skills	1+5 = 6	
	Vignesh M.K.	B. E	6 Years	Aptitude	2+3 = 5	
	Ananth P	B. E	15 Years	Technical & Aptitude	2 + 5 = 7	
Assessment -Own Portal Available					25	

III Sem (KSIIT)

17 + 0.25

IV Sem (KSIIT)

20 + 0.25

+



Transit	Beena N	B.Sc, MS, PGDBA	22 Years	Behaviour skills, Aptitude	4+5 = 9	AVG Score - 28/4 = 7 (Offline) = 23/Student/Hr + GST
	Sowmya Kerur	B E	08 Years	Aptitude	2+4 = 6	
	AMIT MONDLE		20 Years	Personality Development	2+3 = 5	
	Arun Kumar	M.Sc, MBA	17 Years	Technical & Aptitude	3+5 = 8	
Assessment - Still Under Development					28	

MBA (I & II)  
19+case

Skill Factory	Raghavan	B.Com & MBA (HR)	14 Years	Soft Skills and Verbal Skills	3+5 = 8	AVG Score - 33/4 = 8.25 (Offline) = 21/Student/Hr + GST
	Nisha	B.Com & MBA (Fin)	10 Years	Logical, Analytical and Verbal	3+5 = 8	
	Dr. Jacob S	Ph.D	14 Years	Placement oriented skills, verbal skills	5+5 = 10	
	Narasimha	B.E (Information Science) & MBA (HR)	8 Years	Logical, Analytical and Verbal	3+4 = 7	
Assessment - Still Under Development					33	

(KSIT + K)  
VII Sem  
20+case  
Naga  
MBA

Universal Education	Avishek Ghosh	B.Sc, MBA	12 Years	Aptitude and Reasoning	3+5 = 8	AVG Score - 34/4 = 8.5 (Offline) = 22/Student/Hr + GST
	V Nandini Nair	B.Sc, MBA	12 Years	Verbal and communication skills	3+5 = 8	
	Ahinshu Ghosh	B.E, MBA	12 Years	Aptitude and Reasoning	4+5 = 9	
	Tapas Guha	B.E, M.Tech	12 Years	Technical Trainer	4+5 = 9	
Assessment - Still Under Development					34	

JV Global	Darshan B V	B.E, Mtech	6 Years	Quantitative & Analytical	4 + 3 = 7	AVG Score - 31/4 = 7.75 (Offline) = 25/Student/Hr + GST
	Bhargav A P	BA, MA	10 Years	Soft skills	4 + 4 = 8	
	Beena N	B.Sc, PG, MS, PGDBA	18 Years	Pre Placement Topics	4 + 5 = 9	
	Beena S	BE, Mtech	6 Years	Quantitative & Analytical	4 + 3 = 7	
Assessment - Still Under Development					31	

Pentagon Space	Yashwanth K N	BBM, MBA	6 Years	Verbal and communication skills	3 + 3 = 6	AVG Score - 30/4 = 7.50 (Offline) = 32/Student/Hr + GST
	Hanu R	BE, M.Tech	08 Years	Technical Trainer	4 + 4 = 8	
	DASHRATH MISAL	B.Com, MA	15 Years	Soft skills and english	3 + 5 = 8	
	ARCHANA M S	B.Com, MBA	13 Years	Soft skills	3 + 5 = 8	
Assessment - Still Under Development					30	

Call the above for negotiations.

6/10/22

Handwritten signature and date: 06/10/22





# K.S INSTITUTE OF TECHNOLOGY

#14, Raghuvanahalli, Kanakapura Main Road, Bengaluru - 560109

Phone: 080-28435722/24 website: www.ksit.ac.in

## \*\* DEPARTMENT OF TRAINING AND PLACEMENTS \*\*

28.10.2022

### PERSONALITY DEVELOPMENT TRAINING PROGRAM FOR FINAL YEAR STUDENTS - 2023 BATCH

Placement department has planned to conduct Personality Development Training Program for 7<sup>th</sup> Semester students (All branches) from 2<sup>nd</sup> to 8<sup>th</sup> November 2022. All HOD's are hereby informed to communicate their final year students regarding the same.

The training will be conducted in old building class rooms. Batch wise details are shared below. All placement coordinators are requested to submit the consolidated attendance of all 5 days to placement department on or before 9<sup>th</sup> November 2022 without fail.

Department wise scheduled is given below for your reference.

Date	Time	BATCH 1	BATCH 2	BATCH 3	BATCH 4	BATCH 5
		CSE (A)	CSE (B)	ECE (A)	ECE + ETE	ME
2 <sup>nd</sup> , 3 <sup>rd</sup> , 4 <sup>th</sup> , 7 <sup>th</sup> & 8 <sup>th</sup> November 2022	8:50 AM – 11:00AM	OB - 104	OB - 105	OB - 106	OB - 007	OB - 008
	11:00AM – 11:15AM	BREAK				
	11:15 AM – 1:15PM	OB - 104	OB - 105	OB - 106	OB - 007	OB - 008
	1:15PM – 1:50PM	LUNCH BREAK				
	1.50PM – 4:00PM	OB - 104	OB - 105	OB - 106	OB - 007	OB - 008

#### NOTE:

1. Students who are absent for the training sessions will not be permitted to attend any campus drives.
2. All students are informed to attend the training compulsory.
3. Students are strictly informed to be present in their allocated rooms only for all days.
4. Placement dress code compulsory.

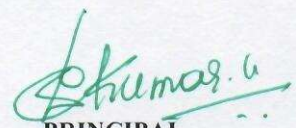

  
PRINCIPAL  
PRINCIPAL  
K.S. INSTITUTE OF TECHNOLOGY  
BENGALURU - 560 109.

CC TO:

HODs and Coordinators of:

CSE	ECE	ETE	ME
-----	-----	-----	----



## UNIVERSAL EDUCATION

### Training for

### KSIT, Bengaluru ( 7<sup>th</sup> Semester)

#### Note-

1. This schedule is for 30 hours, commencing from November 2<sup>nd</sup> to 8<sup>th</sup> ( excluding 5<sup>th</sup> and 6<sup>th</sup> )
2. There will be 6 hours of Training per day per batch.
3. Keeping 300 students we have divided batches into 5.
4. As per the requirement we will keep the link active for pre-assessment from 29<sup>th</sup> October ( 9am ) to 31<sup>st</sup> October ( 9pm).
5. We will keep the link active for post assessment from 8 November ( 8pm) to 9 November ( 8 pm)

Please find below the syllabus lesson plan.

Q.A- Quantitative Aptitude

V.A- Verbal Aptitude

R.A- Reasoning Aptitude

R.P- Resume Preparation

H.R- Human Resource

G.D- Group Discussion

P.D- Personality Development

M.I- Mock Interview



**Puzz- Puzzles**

DATE	TIME	BATCH 1	BATCH 2	BATCH3	BATCH4	BATCH 5	
2 <sup>nd</sup> Nov	9.00AM -11.00AM	Q.A1	Q.A2	V.A1 (Projector)	P.D+ R.P (Projector)	G.D1	
	11.00AM - 11.15AM	TEA BREAK					
	11.15AM - 1.15PM	V.A1	P.D+R.P	Q.A1	Q.A2	G.D1	
	1.15PM – 1.55PM	LUNCH BREAK					
	2.00PM – 4.00PM	G.D1	V.A1	P.D+R.P	Q.A1	Q.A2	

DATE	TIME	BATCH 1	BATCH 2	BATCH3	BATCH4	BATCH 5	
3 <sup>rd</sup> Nov	9.00AM -11.00AM	G.D1	Q.A1	Q.A2	V.A1	P.D+R.P	
	11.00AM - 11.15AM	TEA BREAK					
	11.15AM - 1.15PM	Q.A2	G.D1	R.A1	V.A2	Q.A1	
	1.15PM – 1.55PM	LUNCH BREAK					
	2.00PM – 4.00PM	P.D+R.P	G.D1	Q.A4	Q.A3	V.A1	

DATE	TIME	BATCH 1	BATCH 2	BATCH3	BATCH4	BATCH 5	
4 <sup>th</sup> Nov	9.00AM -11.00AM	Q.A4	Q.A3	G.D1	R.A1	V.A2	
	11.00AM - 11.15AM	TEA BREAK					
	11.15AM - 1.15PM	V.A2	R.A1	G.D1	Q.A4	Q.A3	
	1.15PM – 1.55PM	LUNCH BREAK					
	2.00PM – 4.00PM	Q.A3	Q.A4	V.A2	G.D1	R.A1	



DATE	TIME	BATCH 1	BATCH 2	BATCH3	BATCH4	BATCH 5		
7 <sup>th</sup> Nov	9.00AM -11.00AM	R.A1	V.A2	Q.A3	G.D1	Q.A4		
	11.00AM - 11.15AM	TEA BREAK						
	11.15AM - 1.15PM	Q.A6	Q.A6	Q.A6	Q.A5 + Puzz	Q.A5 + Puzz		
	1.15PM – 1.55PM	LUNCH BREAK						
	2.00PM – 4.00PM	Q.A5 + Puzz	Q.A5+ Puzz	Q.A5+ Puzz	Q.A6	Q.A6		

DATE	TIME	BATCH 1	BATCH 2	BATCH3	BATCH4	BATCH 5		
8 <sup>th</sup> Nov	9.00AM -11.00AM	M.I	M.I	M.I	M.I	M.I		
	11.00AM - 11.15AM	TEA BREAK						
	11.15AM - 1.15PM	M.I	M.I	M.I	M.I	M.I		
	1.15PM – 1.55PM	LUNCH BREAK						
	2.00PM – 4.00PM	M.I + H.R	M.I + H.R	M.I + H.R	M.I + H.R	M.I + H.R		







44	1KS19CS048	LIKITH G	1	2	A	3	4	A	5	6	7	8	9	A	10	11	A	11	9	
45	1KS19CS049	LISHA C	A	A	A	A	A	A	1	2	A	A	A	A	A	A	A	A	02	1
46	1KS19CS050	MAHAK SHREE	A	A	A	A	A	A	A	A	A	A	A	A	A	A	A	A	(00)	0
47	1KS19CS051	MALLIPALLI SPURTHI REDDY	1	2	A	3	4	A	5	6	7	8	9	10	A	A	A	A	10	6
48	1KS19CS052	MANASA G L	1	2	A	A	A	A	3	4	5	6	7	8	9	10	A	A	10	6
49	1KS19CS053	MOHAMMED NOOR AMAN	A	A	A	1	2	3	4	5	6	7	8	9	A	10	11	11	8	
50	1KS19CS054	MUKESH KUMAR	A	A	A	A	A	A	A	A	A	A	A	A	A	A	A	A	(00)	0
51	1KS19CS055	MYTHREYI U	A	A	A	1	2	3	4	5	6	7	8	9	A	A	A	A	09	6
52	1KS19CS056	N ASHOK	A	A	A	A	A	A	A	A	1	2	3	4	5	A	A	A	05	3
53	1KS19CS057	N BHAVYA	1	2	A	3	4	A	5	6	7	8	9	10	A	A	A	A	10	6
54	1KS19CS058	N P SHASHANKA RAO	1	2	A	3	4	A	5	6	A	7	8	9	A	A	A	A	09	5
55	1KS18CS011	BHARATH R	A	A	A	1	A	A	A	A	A	2	3	A	A	A	A	A	03	2
56	1KS19CS116	VRATHIKA BILLAVA	1	2	A	A	A	A	A	A	A	3	4	5	6	7	A	A	07	4
57	1KS20CS400	AKIF DELVI	A	A	A	A	A	A	A	A	A	A	A	A	A	A	A	A	(00)	0
58	1KS20CS404	PRANAV CHANDRAN P	A	A	A	A	A	A	A	A	A	A	A	A	A	A	A	A	(00)	0
59	1KS20CS402	KEERTHI KUMAR V	1	A	A	A	A	A	A	A	A	2	3	4	A	5	A	A	05	4
No. of Students Absent			34	44	54	38	38	50	31	26	32	21	20	24	48	43	53	(10)		
No. of Students Present			25	15	05	21	21	09	28	33	27	38	39	35	11	16	06	49		
Signature of trainer/Placement Coordinator																				







# K.S INSTITUTE OF TECHNOLOGY, BENGALURU

CONSOLIDATED ATTENDANCE FOR PDTP\_2023 BATCH

CSE (B) - OB 105

IV YEAR			VII SEMESTER							'B' SECTION								
S. No	USN	NAME OF THE STUDENT	Dates															TOTAL
			02/11/2022			03/11/2022			04/11/2022			07/11/2022			08/11/2022			
			1	2	3	4	5	6	7	8	9	10	11	12	13	14	15	
1	1KS19CS059	NAVEEN K M	A	A	A	A	A	A	A	1	A	2	A	A	A	A	A	02
2	1KS19CS060	NEELAMMA SALI	1	A	A	A	A	A	2	3	A	A	A	A	A	A	A	03
3	1KS19CS061	NETHRA R	A	A	A	A	A	A	1	A	A	A	A	A	A	A	A	01
4	1KS19CS062	NIKHIL CHOWDARY V R	1	A	A	2	A	A	3	A	4	5	A	A	6	A	A	06
5	1KS19CS063	NITHYA S N	1	A	2	A	A	A	3	4	A	5	A	A	6	A	A	06
6	1KS19CS064	PAVAN B INDRESH	A	A	A	A	A	A	A	A	A	A	A	1	A	A	01	
7	1KS19CS065	PAVAN L	1	A	A	2	A	A	3	A	4	5	A	A	6	A	A	06
8	1KS19CS066	PAVITHRA S P	A	A	A	A	A	A	A	A	A	A	A	A	A	A	A	00
9	1KS19CS067	POOJA J	A	A	A	A	A	A	1	2	3	A	A	A	A	A	A	03
10	1KS19CS068	POTHURU SAI PRIYANKA	A	A	A	1	2	A	3	4	5	6	7	A	A	A	A	07
11	1KS19CS069	PRAJWAL G	1	2	A	3	4	A	A	5	A	A	A	A	A	A	A	05
12	1KS19CS070	PRAJWAL KULKARNI	A	A	A	1	2	A	3	4	A	5	A	A	A	A	A	05
13	1KS19CS071	PREETHI K P	A	A	A	1	2	A	3	4	A	5	A	A	A	A	A	05
14	1KS19CS072	PRIYA E	1	A	2	A	A	A	3	4	A	5	A	A	A	A	A	05
15	1KS19CS073	PRIYANKA R	1	A	A	2	A	A	3	4	5	6	A	A	A	A	A	06
16	1KS19CS074	PUVAN KUMAR V	A	A	A	A	A	A	A	A	A	1	A	A	A	A	A	01
17	1KS19CS075	R V YASHVANTH	A	A	A	A	A	A	A	A	A	1	A	A	A	A	A	01
18	1KS19CS076	RAJ KUMAR	A	A	A	A	A	A	A	A	A	A	A	A	A	A	A	00
19	1KS19CS077	RAKESH M J	1	A	A	A	A	A	A	A	A	2	A	A	A	A	A	02
20	1KS19CS078	RAKSHA T M	1	2	A	3	A	A	4	5	6	7	8	A	A	A	A	08
21	1KS19CS079	RANJITHA D V	A	A	A	1	2	A	3	4	5	6	7	A	A	A	A	07
22	1KS19CS080	SAHANA S	1	A	A	A	A	A	A	A	A	2	A	A	A	A	A	02
23	1KS19CS081	SAI SHIRISHA S B	1	2	3	4	5	A	6	7	8	9	10	11	A	A	A	11
24	1KS19CS082	SANGHARSH KUMAR RAI	A	A	A	A	A	A	A	A	A	A	A	A	A	A	A	00
25	1KS19CS083	SANJEEV MYSORE	A	A	A	A	A	A	A	A	A	1	A	A	A	A	A	01
26	1KS19CS084	SANKALP KESTI	A	A	A	A	A	A	A	A	A	A	A	A	A	A	A	00
27	1KS19CS085	SATISH V	1	2	A	A	A	A	3	4	5	6	7	A	A	8	A	08
28	1KS19CS086	SHANVI B P	1	2	3	4	5	A	6	7	8	9	A	A	A	A	A	09
29	1KS19CS087	SHIVANI G K	A	A	A	A	A	A	1	2	A	A	A	A	A	A	A	02
30	1KS19CS088	SHREESHA S	A	A	A	A	A	A	A	A	A	1	A	A	A	A	A	01
31	1KS19CS089	SHREYA R KIRAN	A	A	A	A	A	A	1	2	A	3	A	A	A	A	A	03
32	1KS19CS090	SHRI HARSHA S	A	A	A	A	A	A	A	A	A	A	A	A	A	A	A	00
33	1KS19CS091	SINDHU S	1	2	A	A	A	A	A	A	A	3	4	A	A	A	A	04
34	1KS19CS092	SMRITHI SHEKAR	A	A	A	A	A	A	1	2	3	4	A	A	A	A	A	04
35	1KS19CS093	SRUJAN K	A	1	A	A	A	A	A	A	A	2	3	A	A	A	A	03
36	1KS19CS094	SRUSTI S GOWDA	A	A	A	A	A	A	1	2	3	4	A	A	A	A	A	04
37	1KS19CS096	SUHAS S	A	A	A	A	A	A	A	A	A	1	A	A	A	A	A	01
38	1KS19CS097	SUSHMITHA K	1	2	A	3	A	A	4	5	6	7	A	A	A	A	A	07
39	1KS19CS098	SWETHA M KULKARNI	1	A	A	A	A	A	2	3	A	4	A	A	A	A	A	04
40	1KS19CS099	SYED ZAINUL ABIDIN	A	1	A	A	A	A	A	2	A	A	A	A	A	A	A	02
41	1KS19CS100	TALLURU MAURYA	A	A	A	A	A	A	A	A	A	1	A	A	A	A	A	01
42	1KS19CS101	TANUSHREE R	A	A	A	1	2	A	3	4	A	5	6	A	A	A	A	06



43	1KS19CS102	TEJAS N	A	A	A	1	A	A	A	A	A	2	A	A	A	A	A	02	2
44	1KS19CS103	TEJAS P	A	A	A	A	A	A	A	A	A	1	2	A	A	A	A	02	1
45	1KS19CS104	TEJASWINI NAYAKA S	1	2	A	3	A	A	4	5	6	7	A	A	A	A	A	07	6
46	1KS19CS105	THANUSHREE S	A	1	A	2	3	A	A	A	A	4	5	A	A	A	A	05	3
47	1KS19CS106	THIRUMAL R	A	1	A	A	A	A	A	A	A	A	A	A	A	A	A	01	1
48	1KS19CS107	THRIVENI U	1	2	3	4	5	A	6	7	8	9	10	A	A	A	A	10	6
49	1KS19CS108	UDHAY KUMAR G	A	A	A	A	A	A	A	A	A	A	A	A	A	A	A	(00)	0
50	1KS19CS109	VAISHNAVI G	A	A	A	A	A	A	A	A	A	A	A	A	A	A	A	(00)	0
51	1KS19CS110	VARSHA BAI R	1	2	A	3	4	A	A	A	A	5	6	A	7	A	A	07	4
52	1KS19CS111	VARUN KAMBALI	A	A	A	1	2	A	A	A	A	A	A	A	A	A	A	02	2
53	1KS19CS112	VISHAL GUPTA	A	A	A	A	A	A	1	2	A	A	A	A	A	A	A	02	1
54	1KS19CS113	YASHWANTH S R	A	1	A	A	A	A	A	A	A	2	3	4	A	A	A	04	3
55	1KS19CS115	AKSHAY R	A	A	A	A	A	A	1	2	A	3	A	A	A	A	A	03	2
56	1KS18CS021	G. SARAYU CHOWDARY	A	A	A	A	A	A	1	2	3	A	A	A	A	A	A	03	2
57	1KS18CS068	PRAJWAL N	A	A	A	A	A	A	1	A	A	A	A	A	A	A	A	01	1
58	1KS20CS401	ANUSHA A R	A	A	A	1	2	A	3	4	5	A	A	A	A	A	A	05	3
59	1KS20CS403	NITHIN S	1	2	A	A	3	A	A	4	A	A	5	6	A	A	A	06	4
No. of Students Absent			33	43	54	39	45	(59)	31	27	42	32	44	56	54	58	(59)	(07)	1
No. of Students Present			20	16	05	20	14	00	28	32	17	37	15	03	05	01	00	52	
Signature of trainer/Placement Coordinator																			







# K.S INSTITUTE OF TECHNOLOGY, BENGALURU

CONSOLIDATED ATTENDANCE FOR PDTP\_2023 BATCH

ECE (A) - OB 106

IV YEAR			VII SEMESTER									'A' SECTION					TOTAL	
S. No	USN	NAME OF THE STUDENT	Dates															
			02/11/2022			03/11/2022			04/11/2022			07/11/2022			08/11/2022			
			1	2	3	4	5	6	7	8	9	10	11	12	13	14	15	
1	1KS19EC001	ABHILASH A S	1	2	A	3	4	5	6	A	A	7	8	9	A	A	A	09
2	1KS19EC002	ABHISHEK CHANDRESH	1	2	A	3	4	A	5	6	7	8	9	10	11	12	13	13
3	1KS19EC003	AISHWARYA BASAVARAJ KEMBAVI	1	2	3	4	5	6	7	8	9	10	11	12	13	14	15	15
4	1KS19EC004	AISHWARYA M G	1	2	A	3	4	5	6	7	8	9	10	11	12	A	A	12
5	1KS19EC005	AKSHAY KUMAR D	1	A	A	2	3	4	5	6	7	A	8	A	9	10	11	11
6	1KS19EC006	AKSHITHA	1	2	3	4	5	6	7	8	9	10	11	A	12	A	A	12
7	1KS19EC007	AMRUTA	1	2	3	4	5	6	7	8	9	A	A	A	10	11	12	12
8	1KS19EC008	AMULYA R	A	A	A	1	2	A	A	A	A	3	4	5	6	7	8	08
9	1KS19EC009	ANITHA S	1	2	3	4	5	6	7	8	9	A	A	A	10	11	12	12
10	1KS19EC010	ANJALI Y J	1	2	A	3	4	5	6	7	8	9	10	11	12	13	14	14
11	1KS19EC011	ARCHANA YADAV M	1	2	3	4	5	6	7	8	9	10	11	12	A	A	A	12
12	1KS19EC012	ASHRITHA R	A	A	A	1	A	A	A	A	A	A	A	A	A	A	A	01
13	1KS19EC014	BHAVANA S	A	A	A	1	2	3	4	5	A	6	7	8	9	A	A	09
14	1KS19EC015	CHAITRA P	1	2	3	A	4	5	6	7	8	9	10	11	12	A	A	12
15	1KS19EC016	CHANDAN RAJ Y	1	2	A	A	A	A	A	A	A	3	4	5	6	7	8	08
16	1KS19EC017	CHANDANA.L	1	2	3	4	5	6	7	8	9	10	11	12	13	A	A	13
17	1KS19EC018	CHENNREDDY RAJASEKHAR	A	A	A	1	2	3	A	A	A	A	4	A	A	A	A	04
18	1KS19EC019	CHIRANTHANA YOGANANDA K	A	A	A	A	A	A	A	A	A	A	A	A	A	A	A	00
19	1KS19EC020	D NAYAN	A	1	A	A	2	3	4	A	A	5	6	7	8	9	A	09
20	1KS19EC021	DANESH RAJU V	A	1	A	2	3	4	5	6	7	8	9	A	10	A	A	10
21	1KS19EC022	DAVINO JOSEPH	A	A	A	1	2	A	A	A	A	3	4	5	6	A	A	06
22	1KS19EC023	DHANYA SUKANTH B K	A	A	A	A	A	A	1	2	3	4	5	6	7	8	9	09
23	1KS19EC024	DHEEMANTH K N	1	2	3	4	5	6	7	8	9	10	11	A	12	A	A	12
24	1KS19EC025	DISHA SHIVANI	A	A	A	1	2	3	4	5	6	7	8	9	10	11	12	12
25	1KS19EC027	GAYATHRI P K	A	A	A	1	A	2	3	4	5	6	7	A	8	9	10	10
26	1KS19EC028	GAYATHRI R WARRIER	A	A	A	1	2	3	4	5	6	7	8	9	10	11	12	12
27	1KS19EC029	GONUGUNTLA SAI SIDDARTHA	1	2	A	3	4	5	A	A	A	6	7	8	9	A	A	09
28	1KS19EC030	GOWRI S NADIGER	1	2	3	4	5	6	A	A	A	7	8	9	10	11	12	12
29	1KS19EC031	HARSHA R	A	A	A	A	A	A	1	2	A	A	A	A	A	A	A	02
30	1KS19EC032	HARSHITHA B Y	A	A	A	1	2	3	4	5	A	6	7	8	9	A	A	09
31	1KS19EC033	HEMANTH.R.PATIL	1	2	A	3	4	5	6	A	A	A	A	A	A	A	A	06
32	1KS19EC035	JAGRUTI PAI	A	A	A	1	2	3	4	5	6	7	8	9	10	11	12	12
33	1KS19EC036	JAYANTH M B	1	2	A	A	3	A	4	5	6	7	8	9	10	11	12	12
34	1KS19EC037	KAMMA MANUBOLU MANOGNA	1	2	3	4	5	6	7	8	9	10	11	A	12	13	A	13
35	1KS19EC038	KARTHIK K	A	A	A	A	A	A	A	A	A	A	A	A	A	A	A	00
36	1KS19EC039	KASHYAP.P	A	A	A	A	A	A	1	2	3	4	5	6	7	8	9	09
37	1KS19EC040	KRUPA.A	1	2	3	A	4	5	6	7	8	9	10	11	12	A	A	12
38	1KS19EC041	KRUTHIK S	1	A	A	2	3	4	5	6	7	8	9	10	11	12	13	13
39	1KS19EC042	LAKSHMAN KUMARA B	1	2	A	3	4	5	6	7	8	9	10	11	A	A	A	11
40	1KS19EC043	LIKITHA.H	1	2	3	A	4	5	6	7	8	9	10	11	12	A	A	12
41	1KS19EC044	M LOKESHWARI	1	2	3	4	5	6	7	8	9	10	11	A	12	A	A	12
42	1KS19EC045	MANU N KANDRA	1	2	3	4	5	6	7	8	9	10	11	A	12	13	A	13



43	1KS19EC046	MEGHANA H P	A	A	A	1	2	3	4	5	6	7	8	9	10	A	A	107
44	1KS19EC047	MOHAMMAD RAKHEEB M R	A	A	A	A	A	A	1	2	3	4	5	A	A	A	054	
45	1KS19EC048	MOHITH KUMAR G	1	2	3	4	5	6	7	8	9	10	11	A	12	A	139	
46	1KS19EC049	MONIKA V ARYA	1	2	3	A	4	5	6	7	8	9	10	11	12	A	129	
47	1KS19EC050	MONISHA.B.K	1	2	3	4	5	6	7	8	9	10	11	12	A	A	128	
48	1KS19EC051	N ANILA	1	2	3	4	5	6	7	8	9	10	11	12	13	A	A	139
49	1KS19EC052	NIDHI S	A	A	A	A	A	A	A	A	A	A	A	A	A	A	A	(00)
50	1KS19EC053	NISARGA K	1	2	A	3	4	5	6	7	8	9	10	11	A	A	A	117
51	1KS19EC054	NITHIN D	1	2	A	A	A	A	A	A	A	A	A	A	A	A	A	02
52	1KS19EC055	PAVAN KUMAR G R	1	2	A	3	4	5	6	7	8	9	10	11	12	A	A	128
53	1KS19EC056	POKURI MOUNIKA	1	A	A	A	2	A	A	A	A	3	4	5	A	A	A	054
54	1KS19EC057	POOJA S P	1	2	3	4	5	6	A	A	A	7	8	9	10	11	12	128
55	1KS19EC058	PRADEEP GADED	A	A	A	A	A	A	A	A	A	A	A	A	A	A	A	(00)
56	1KS19EC059	PRAKASH CHEGORE	A	A	A	A	A	A	A	A	A	A	A	A	A	A	A	(00)
57	1KS19EC061	PRASHANTH.S.K	A	A	A	A	A	A	A	A	A	A	A	A	A	A	A	(00)
58	1KS19EC062	PRAVEEN KUMAR N	A	A	A	1	2	3	4	5	6	7	8	9	10	A	A	107
59	1KS19EC063	PREETHAM G H	1	2	A	A	A	A	3	4	5	6	7	A	A	A	A	074
60	1KS19EC064	PRIYANKA K	1	2	3	4	5	6	7	8	9	A	10	A	11	A	A	118
61	1KS19EC065	RADHA KRISHNA L	1	A	A	2	3	4	5	6	A	7	8	9	10	11	A	118
62	1KS19EC066	RAJALAKSHMI S	1	2	3	4	5	6	7	8	A	9	10	A	A	A	A	6
No. of Students Absent			24	26	41	21	16	19	16	19	24	15	12	26	20	40	13	(06)
No. of Students Present			38	36	21	41	46	43	46	43	38	47	50	36	42	22	19	56
Signature of trainer/Placement Coordinator			Ra	Ra	Ra	Ra	Ra	Ra	Ra	Ra	Ra	Ra	Ra	Ra	Ra	Ra	Ra	Ra







# K.S INSTITUTE OF TECHNOLOGY, BENGALURU

CONSOLIDATED ATTENDANCE FOR PDTP\_2023 BATCH

ECE (B) + ETE - OB 007

IV YEAR			VII SEMESTER							'B' SECTION								
S. No	USN	NAME OF THE STUDENT	Dates															TOTAL
			02/11/2022			03/11/2022			04/11/2022			07/11/2022			08/11/2022			
			1	2	3	4	5	6	7	8	9	10	11	12	13	14	15	
1	1KS19EC067	RAMYASREE R	A	A	A	1	2	3	4	5	6	A	A	A	A	A	A	06
2	1KS19EC068	RANGASWAMY.U	A	A	A	A	A	A	A	A	A	1	2	3	4	5	A	05
3	1KS19EC069	ROHAN K R	A	1	A	2	3	4	A	A	A	5	6	7	8	A	A	08
4	1KS19EC070	S K BHARATESH	1	2	A	3	4	5	6	7	8	9	10	11	12	13	A	13
5	1KS19EC071	SABARISH I J	1	2	3	4	5	6	7	8	9	10	11	A	12	13	14	14
6	1KS19EC073	SAHANA S	1	2	3	4	5	6	7	8	9	10	11	A	12	A	A	12
7	1KS19EC074	SAI PRIYA T S	1	2	A	3	4	A	5	6	A	7	8	A	A	A	A	08
8	1KS19EC075	SAMIKSHA S	1	2	3	4	5	6	7	8	9	A	10	11	12	A	A	12
9	1KS19EC076	SANTOSH HEGDE	1	2	A	3	4	5	6	7	8	9	10	A	11	12	13	13
10	1KS19EC077	SATHVIK U M	1	2	A	3	4	5	A	A	A	6	7	A	8	9	10	10
11	1KS19EC078	SHAMITHA BIJOOR	1	2	3	4	5	6	7	8	9	10	11	12	13	A	A	13
12	1KS19EC079	SHASHANK KASHYAP.H.R	1	2	3	4	5	6	A	7	8	A	9	A	10	11	12	12
13	1KS19EC081	SHREYAMS D K	1	2	3	4	5	6	7	8	A	A	9	10	A	11	12	12
14	1KS19EC082	SHREYAS B ARADHYA	1	2	A	3	4	5	6	7	8	9	10	11	12	13	A	13
15	1KS19EC083	SHREYAS GOWDA	1	2	3	4	A	5	6	7	A	A	8	9	10	11	A	11
16	1KS19EC084	SHREYAS V BHARADWAJ	1	2	3	A	4	5	6	7	8	9	A	A	10	11	A	11
17	1KS19EC085	SHUBHAM KUMAR SINGH A	1	A	A	A	A	2	3	4	5	A	6	7	8	9	A	09
18	1KS19EC086	SINCHANA M N	1	2	3	4	5	6	7	8	9	10	11	12	13	A	A	13
19	1KS19EC087	SRINIVAS S	1	2	3	4	5	6	7	8	9	A	10	11	12	13	A	13
20	1KS19EC088	SRINIVASAN M	1	2	A	3	4	5	6	7	8	9	10	A	11	12	A	12
21	1KS19EC089	SRIRAM	1	2	3	4	A	A	A	A	A	A	5	6	7	8	A	08
22	1KS19EC090	SUHAS.M	A	A	A	1	A	A	A	A	A	A	A	A	2	3	4	04
23	1KS19EC092	SUMUKHA VASISHTA M R	1	2	3	4	5	6	A	A	A	7	8	9	10	11	12	12
24	1KS19EC093	SUSHMITHA S	1	2	3	4	5	6	7	8	9	10	11	12	13	A	A	13
25	1KS19EC094	SWAGATH AITHAL P G	A	1	2	A	3	4	5	6	7	8	9	A	10	11	12	12
26	1KS19EC095	SWATHI U	1	2	3	4	5	6	7	8	A	9	10	11	A	A	A	11
27	1KS19EC096	T N L RUTHVIK	A	1	2	3	4	5	6	7	8	9	10	A	11	12	13	13
28	1KS19EC097	TEJASHWINI P V	1	2	A	3	4	A	A	A	A	5	6	A	A	A	A	06
29	1KS19EC098	THEERTHANA S R	1	2	3	4	5	6	7	8	9	A	10	11	12	A	A	12
30	1KS19EC099	TUSHAR R VASISHTA	A	A	A	A	A	1	2	3	4	5	6	7	A	A	A	07
31	1KS19EC100	VAISHNAVI K	1	2	3	4	5	6	7	8	9	10	11	12	13	A	A	13
32	1KS19EC101	VANDANA G	1	2	3	4	5	6	A	A	A	7	8	9	10	A	A	10
33	1KS19EC102	VANDANA S	1	2	3	4	5	6	7	8	A	9	10	11	12	A	A	12
34	1KS19EC103	VIGNESH MUTHAIAH R	1	2	3	4	5	A	6	7	A	8	9	10	11	12	A	12
35	1KS19EC104	VIKAS S	A	A	A	A	A	A	1	2	3	4	5	6	A	A	A	06
36	1KS19EC105	VINUTH S REDDY	A	A	A	1	A	A	2	3	A	A	4	5	6	7	A	07
37	1KS19EC106	VISHAL SANJAY RAJU	A	A	A	1	2	A	3	4	5	A	6	7	A	A	A	07
38	1KS19EC107	VISHNU RAATA YADUNANDAN	A	A	A	1	2	3	A	A	A	5	6	A	A	A	A	06
39	1KS19EC108	YASHASWINI N	1	2	3	4	A	A	5	6	A	A	A	A	A	A	A	06
40	1KS18EC089	SNEHA N	1	2	A	3	4	5	6	7	A	8	9	A	10	A	A	10
41	1KS20EC400	MADALA VIVEK KUMAR	1	A	A	A	2	3	4	5	A	A	A	A	6	A	A	06
42	1KS20EC401	RANJANA P	A	1	2	3	4	5	A	6	A	7	8	A	A	A	A	08



43	1KS20EC402	SINDHU J	A	A	A	A	A	A	1	2	3	A	4	5	A	A	A	05	4
44	1KS18TE005	ANKITHA . N	A	1	A	A	2	3	A	4	A	5	6	7	A	A	A	07	6
45	1KS19ET002	CHAITRA C	1	2	3	4	5	6	7	8	9	A	A	A	A	A	A	09	6
46	1KS19ET003	LITCHITHA M GOWDA	A	A	A	A	A	A	1	2	A	A	A	A	A	A	A	02	1
47	1KS19ET004	MAHADEV A C	A	A	A	1	2	A	3	A	A	4	5	A	A	A	A	05	3
48	1KS19ET005	MRUTHYUNJAYA GUDIBANDE	A	A	A	1	2	A	3	4	A	5	6	A	A	A	A	06	3
49	1KS19ET006	N NELBIN	A	A	1	2	3	A	4	A	A	5	6	A	A	A	A	06	4
50	1KS19ET007	NIRANJAN S RAO	A	A	A	1	2	A	3	A	A	4	5	4	A	A	A	05	3
51	1KS19ET008	RISHI KUMAR S	A	A	A	A	A	A	1	A	A	2	3	A	A	A	A	03	2
52	1KS19ET009	ROHIT KUMAR	A	A	A	A	A	A	A	A	A	A	A	A	A	A	A	(60)	0
53	1KS19ET010	SHREYAS C R	A	A	A	A	A	A	1	2	3	4	5	6	A	A	A	06	4
54	1KS19ET011	SHWETHA K	1	2	3	4	5	6	7	8	9	10	11	A	A	A	A	11	7
55	1KS19ET012	VAISHNAVI S	A	A	A	1	2	3	4	5	A	A	A	A	A	A	A	05	3
No. of Students Absent			23	20	29	14	14	19	13	14	28	20	09	27	24	35	46	(01)	
No. of Students Present			32	35	26	41	41	36	42	41	27	35	46	28	31	20	09	54	
Signature of trainer/Placement Coordinator			<i>[Signature]</i>	<i>[Signature]</i>	<i>[Signature]</i>	<i>[Signature]</i>	<i>[Signature]</i>	<i>[Signature]</i>	<i>[Signature]</i>	<i>[Signature]</i>	<i>[Signature]</i>	<i>[Signature]</i>	<i>[Signature]</i>	<i>[Signature]</i>	<i>[Signature]</i>	<i>[Signature]</i>	<i>[Signature]</i>	<i>[Signature]</i>	







# K.S INSTITUTE OF TECHNOLOGY, BENGALURU

CONSOLIDATED ATTENDANCE FOR PDTP\_2023 BATCH

ME - OB 008

IV YEAR			VII SEMESTER															
S. No	USN	NAME OF THE STUDENT	Dates															
			02/11/2022			03/11/2022			04/11/2022			07/11/2022			08/11/2022			TOTAL
			1	2	3	4	5	6	7	8	9	10	11	12	13	14	15	
1	1KS19ME001	ACHINTYA S SAROVAR	A	A	A	1	2	A	3	4	5	6	7	8	9	10	11	11
2	1KS19ME002	ADVAIT SIDDANTH K V	A	A	A	A	A	A	A	A	A	A	A	A	A	A	A	00
3	1KS19ME003	AJITH KUMAR R	1	A	2	3	4	5	6	7	8	9	10	11	12	13	14	14
4	1KS19ME004	ARUN KUMAR M	1	2	3	A	A	A	4	5	A	6	7	8	9	10	11	11
5	1KS19ME005	BHAVAN KASHYAP K	A	A	A	A	A	A	A	A	A	1	2	3	4	5	A	05
6	1KS19ME008	CHARITHA S	1	2	3	A	A	A	4	5	A	6	7	8	9	10	11	11
7	1KS19ME009	DARSHAN N	A	A	A	A	A	A	A	A	A	1	A	A	A	A	A	01
8	1KS19ME010	DHANUSH GOWDA M	1	2	A	3	A	A	4	5	A	6	7	A	A	A	A	07
9	1KS19ME011	HEMANTH K	A	A	A	A	A	A	1	2	3	A	A	A	A	A	A	03
10	1KS19ME013	JASHWANTH S	1	2	3	4	A	A	5	6	A	7	8	9	10	11	12	12
11	1KS19ME014	JAYANTH T K	1	2	A	3	A	A	A	A	A	4	5	A	6	A	A	06
12	1KS19ME015	JEEVAN B S	1	2	A	3	A	A	4	5	6	7	8	9	10	A	A	10
13	1KS19ME016	JITHAN A	1	2	3	4	5	6	7	8	9	10	11	12	13	14	15	15
14	1KS19ME017	MADHU V	1	2	A	3	4	A	5	6	7	8	9	10	11	12	13	13
15	1KS19ME018	MANUKUMAR D K	A	1	A	2	A	A	3	4	5	6	7	8	A	A	A	08
16	1KS19ME019	NIHAL M L	1	2	A	3	4	5	6	7	8	9	10	11	12	13	A	13
17	1KS19ME020	NITHESH S R	1	2	A	3	A	A	4	5	6	7	8	9	A	10	11	11
18	1KS19ME021	PRAJWAL KUMAR R	A	A	A	1	A	A	2	3	4	5	6	A	7	A	A	07
19	1KS19ME022	PRASANNA KUMAR S G	A	A	A	1	A	A	A	2	3	4	5	A	A	A	A	05
20	1KS19ME023	PRATHAP REDDY T M	A	A	A	A	A	A	A	A	A	1	2	A	A	A	A	02
21	1KS19ME024	R DEEPAK A RAO	A	1	A	2	A	A	3	4	A	5	6	7	8	A	A	08
22	1KS19ME025	R MANOJ REDDY	1	2	A	3	A	A	4	5	A	6	7	8	9	10	A	10
23	1KS19ME026	RAHUL R	1	2	A	3	A	A	4	5	6	7	A	8	9	10	A	10
24	1KS19ME027	RAKSHITH NAGESH	A	1	A	2	A	A	3	4	A	A	A	A	5	A	A	05
25	1KS19ME028	RAMACHANDRA S	A	A	A	A	A	A	1	2	3	4	A	5	6	7	A	07
26	1KS19ME029	SANJAY.V	A	A	A	1	2	A	3	4	A	5	6	7	8	9	10	10
27	1KS19ME030	SHREYAS B	A	A	A	A	A	A	A	A	A	1	A	A	A	A	A	01
28	1KS19ME031	SHREYAS H VASIST	A	A	A	A	A	A	A	A	A	A	A	A	A	A	A	00
29	1KS19ME032	SRIKRISHNA SANTHOSH K	1	2	A	3	A	A	4	5	A	6	A	7	8	9	A	09
30	1KS19ME033	SUJAY ADITHYA	1	2	A	3	A	A	A	A	A	4	5	A	6	A	A	06
31	1KS19ME034	SYED ASMA ASHEER	1	2	A	3	A	A	4	5	6	7	A	8	9	10	A	10
32	1KS19ME035	THEJAS V R	A	A	A	A	A	A	A	A	A	1	A	A	A	A	A	01
33	1KS19ME036	TILAK P	A	1	A	2	A	A	3	4	A	5	6	7	8	9	10	10
34	1KS19ME037	VAISHNAV H	1	2	3	4	A	A	A	A	A	5	6	7	A	8	9	09
35	1KS19ME039	VENKATRAMANA G BHAT	1	2	3	4	A	A	5	6	A	7	8	9	10	11	12	12
36	1KS19ME040	ZAFFAR ABDULLAH SHEIKH	A	A	A	A	A	A	A	A	A	A	A	A	A	A	A	00
37	1KS18ME001	ABHISHEK MANIKUMAR	A	1	A	A	A	A	2	3	4	5	6	7	8	A	A	08
38	1KS18ME008	ANUSH S	A	1	A	A	A	A	2	A	3	4	5	6	7	A	A	07
39	1KS18ME010	ATIF MANSOOR SHAIK	A	1	A	A	A	A	A	2	A	3	4	A	A	A	A	04
40	1KS18ME024	KARTHIK G S	A	1	A	A	A	A	A	2	A	3	4	A	A	A	A	04
41	1KS18ME048	PRAJWAL NIKAM	A	1	A	2	3	4	A	5	6	A	A	7	A	A	8	08
42	1KS18ME056	ROHITH S	1	2	A	3	4	5	6	7	8	9	10	11	12	13	A	13



43	1KS18ME057	ROJA G NAIK	A	A	A	A	A	A	1	2	3	4	5	6	7	8	A	08
No. of Students Absent			24	16	36	17	35	38	15	12	24	06	13	16	16	22	30	03
No. of Students Present			19	24	07	26	08	05	28	31	19	37	30	27	27	21	13	29
Signature of trainer/Placement Coordinator																		





**AXIS BANK LTD**  
JPNAGAR 6TH PHASE BANAGLORE [K. BENGALURU, 560078  
IFS CODE - UTIB0001513

A/C. PAYEE ONLY

VALID FOR THREE MONTHS FROM THE DATE OF ISSUE  
DATE 08/11/2022  
दिनांक 08 11 20 22  
D D M M Y Y Y Y

SESHASAI (M) CTS 2010 22/07/2022 5144672

Pay Bizotic Talent Solutions Pvt Ltd

OR BEARER / या धारक को

रुपये Rupees Fifty two thousand one hundred

*only*

अदा करें

₹ 52,100/-

A/C NO. 912010014093916

PLTRS 000160

For K S INSTITUTE OF TECHNOLOGY

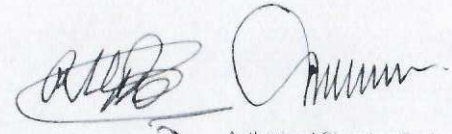

Authorized Signatory(ies)

Please sign above

Payable at par at all branches of Axis Bank Ltd in India.

⑈ 224435⑈ 560211034⑈ 000160⑈ 31

Received on 24/11/22







**KSIT**  
K.S. INSTITUTE OF TECHNOLOGY

Kammavari Sangham (R) 1952  
K.S. GROUP OF INSTITUTIONS

ಕೆ.ಎಸ್. ಕಾಂತ್ರಿಕ ಮಹಾವಿದ್ಯಾಲಯ

**K.S. INSTITUTE OF TECHNOLOGY**

Accredited By NAAC

# 14, Raghuvanahalli, Kanakapura Road, Bengaluru - 560 109.

Tel : 080 28435722 / 24, Fax : 080 28435723

E-mail : principal.ksit@gmail.com / principal@ksit.edu.in | website : www.ksit.edu.in

Ref: KSIT/PO/2022-2023/TPO 004

Date: 23/09/2022

To,  
Bizotic Talent Solutions Pvt Ltd.  
#15, 3rd Main, 3rd Cross, Maruthi Nagar, Shreyas Colony  
J P Nagar 7th Phase, Bengaluru - 560078

Dear Sir,

**Sub:** Purchase Order for NTT Data Company Specific Training for BE 2023 Batch Students.

With reference to the above, we are pleased to place the order for **NTT Data Company Specific Training** for final Year **BE Students** at **K.S. Institute of Technology**, #14, Raghuvanahalli, Kanakapura Road, Bangalore – 109 as per the following specifications, terms & conditions.

**Programme Commercials:**

Sl.No.	Description	Quantity	Rate	Amount
1	NTT Data Company Specific Training for BE 2023 Batch Students	134	Rs. 20/Hour/Student (134 × 18Hrs × 20Rs)	48240/-
	Total			48240/-
	Taxable Value			48240/-
	ADD: CGST 9%			4342/-
	ADD: SGST 9%			4342/-
	<b>Grand TOTAL</b>			<b>56,924/-</b>
<b>Amount in Words:</b> Rupees Fifty Six Thousand Nine Hundred and Twenty Four Only				

**Terms & Conditions:**

- Training dates for 7<sup>th</sup> Semester students would be from 26<sup>th</sup> - 28th September 2022.
- Company specific Mock Test to be conducted between 1<sup>st</sup> to 11<sup>th</sup> October 2022 in three sets
- Full Payment to be made post satisfactory completion of the training.

Thanking you,

  
07/11/22  
Hon. Secretary

KAMMAVARI SANGHAM



## TAX INVOICE



## BIZOTIC TALENT SOLUTIONS PRIVATE LIMITED

#15, 3rd Main, 3rd Cross, Maruthi Nagar, Shreyas Colony

J P Nagar 7th Phase, Bengaluru - 560078

GSTIN No. 29AAGCB3936K1ZB

Bill to	Place of Supply	INVOICE No	Dated
K.S. Institute of Technology #14, Raghuvanahalli, Kanakapura Road Bengaluru - 560109 GSTIN No	K.S. Institute of Technology #14, Raghuvanahalli, Kanakapura Road Bengaluru - 560109	2022-23/46	07-Oct-22
COMMENTS:			

DESCRIPTION OF SERVICES	RATE DESCRIPTION		SAC CODE	AMOUNT
	No. of Students	Rate per Student		
Campus Alliance Program - NTT Data Company Specific Training for 7th Semester Engineering students - 2023 BATCH	134	360	999293	48240

<b>TOTAL</b>				48240
--------------	--	--	--	-------

--	--	--	--	--

Taxable Value				48240
---------------	--	--	--	-------

ADD: CGST 9%				4342
--------------	--	--	--	------

ADD: SGST 9%				4342
--------------	--	--	--	------

--	--	--	--	--

<b>TOTAL</b>				56924
--------------	--	--	--	-------

Amount (in words)				
-------------------	--	--	--	--

Rupees Fifty Six Thousand Nine Hundred and Twenty Four Only				
---	--	--	--	--

--	--	--	--	--

Cheques/DD Payable To: BIZOTIC TALENT SOLUTIONS PRIVATE LIMITED				
---	--	--	--	--

--	--	--	--	--

Our Bank details for RTGS / NEFT Transfer				
---	--	--	--	--

Bank	HDFC BANK			
------	-----------	--	--	--

Branch	J P NAGAR 5th PHASE, BANGALORE			
--------	--------------------------------	--	--	--

Account Number	50200012222162			
----------------	----------------	--	--	--

Type of Account	CURRENT ACCOUNT			
-----------------	-----------------	--	--	--

IFSC Code	HDFC0003824			
-----------	-------------	--	--	--

Company PAN	AAGCB3936K			
-------------	------------	--	--	--

FOR BIZOTIC TALENT SOLUTIONS PRIVATE LIMITED

Authorised Signatory



Tax may be deducted at Source @ 10% under section 194J of the Income Tax Act, 1961. Tax should not be deducted on the GST component charged on the invoice as per Circular No. 23 of 2017 dated 19th July 2017 issued by the Central Board of Direct Taxes, Ministry of Finance, Govt of India.

WE THANK YOU FOR YOUR CONTINUED PATRONAGE WITH US





# K.S INSTITUTE OF TECHNOLOGY

#14, Raghuvanahalli, Kanakapura Main Road, Bengaluru - 560109

Phone: 080-28435722/24 website: www.ksit.ac.in

## \*\* DEPARTMENT OF TRAINING AND PLACEMENTS \*\*

23.09.2022

### REVISED CIRCULAR

#### NTT DATA COMPANY SPECIFIC TRAINING PROGRAM FOR 2023 BATCH

Placement department have planned to conduct **NTT DATA company specific training program** for 2023 batch students from 26<sup>th</sup> to 28<sup>th</sup> September 2022. All eligible students are informed to attend the training program without fail. All HOD's are hereby informed to communicate their final year students regarding the same. All **placement coordinators** are **requested to attend** the same. Department wise scheduled is given below for your reference.

Date	Time	BATCH 1	BATCH 2
		CSE (NB SH 204)	ECE (NB SH 403)
26 <sup>th</sup> to 28 <sup>th</sup> September 2022	9:00 AM – 11:00AM	Trainer 1	Trainer 2
	11:00AM – 11:15AM	BREAK	
	11:15 AM – 1:15PM	Trainer 2	Trainer 1
	1:15PM – 1:55PM	LUNCH BREAK	
	2:00PM – 4:00PM	Trainer 1	Trainer 2

#### NOTE:

1. All eligible students are informed to attend the training compulsory.
2. Students are strictly informed to be present in their allocated rooms only for all days.
3. Placement dress code compulsory.
4. Unregistered students are informed to attend their regular classes without fail.



*[Signature]*

PRINCIPAL

PRINCIPAL

K.S. INSTITUTE OF TECHNOLOGY  
BENGALURU - 560 109.

CC TO:  
HODs and Coordinators of:

CSE <i>[Signature]</i>	ECE <i>[Signature]</i>
------------------------	------------------------

*[Handwritten initials: ME, TCE, Sabar]*



## TRAINING MODLULE FOR NTT DATA COMPANY SPECIFIC TRAINING

Batch	26.09.2022 - Monday		
	9:00 am to 11:00 am	11:15 am to 1:15 pm	2:00 pm to 4:00 pm
Batch 1 CSE	Technical	Aptitude 1	Technical
Batch 2 ECE	Aptitude 1	Technical	Logical Reasoning 1

Batch	27.09.2022 - Tuesday		
	9:00 am to 11:00 am	11:15 am to 1:15 pm	2:00 pm to 4:00 pm
Batch 1 CSE	9 am to 12:15 pm- Verbal 1 12:15 pm to 1:15 pm- Aptitude 2		Aptitude 2
Batch 2 ECE	9 am to 12:15 pm- Aptitude 2 12:15 pm to 1:15 pm- Verbal 1		Verbal 1

Batch	28.09.2022 - Wednesday		
	9:00 am to 11:00 am	11:15 am to 1:15 pm	2:00 pm to 4:00 pm
Batch 1 CSE	Logical Reasoning 1	Technical	Logical Reasoning 2
Batch 2 ECE	Technical	Logical Reasoning 2	Technical





## TRAINING TIMETABLE

### Time Table for Batch 1

Sl. No.	Date	Day	Duration	Topic	Trainer
1	26-09-22	Monday	4	Technical	Vedavathi
2			2	Quantitative Aptitude	Shashank
3	27-09-22	Tuesday	3	Verbal	Srinath Sheturaman
4			3	Quantitative Aptitude	Vineet Mann
5	28-09-22	Wednesday	4	Logical Reasoning	Vineet Mann
6			2	Technical	Vedavathi
		<b>Total</b>	<b>18</b>		





## TRAINING TIMETABLE

### Time Table for Batch 2

Sl. No.	Date	Day	Duration	Topic	Trainer
1	26-09-22	Monday	4	Quantitative Aptitude	Shashank
2			2	Technical	Vedavathi
4	27-09-22	Tuesday	3	Quantitative Aptitude	Vineet Mann
5			3	Verbal	Srinath Sheturaman
7	28-09-22	Wednesday	4	Technical	Vedavathi
8			2	Logical Reasoning	Vineet Mann
		<b>Total</b>	<b>18</b>		







# K.S INSTITUTE OF TECHNOLOGY, BENGALURU

## DEPARTMENT OF TRAINING AND PLACEMENTS

### ATTENDANCE FOR NTT DATA COMPANY SPECIFIC TRAINING (BATCH 1) - NB SH 204

IV YEAR			VII SEMESTER									
S. No	USN	NAME OF THE STUDENT	Dates									Total (05)
			26/09/2022			27/09/2022			28/09/2022			
			1	2	3	4	5	6	7	8	9	
1	1KS19CS036	INDRAJITH H M	1	2	3	4	5	6	7	8	9	9
2	1ks19cs040	Kalyan chowdhary b	1	2	A	A	A	A	A	A	A	2
3	1KS19CS097	Sushmitha K	1	A	A	A	A	A	2	3	A	3
4	1KS19CS020	C N Shreyas	1	2	3	4	5	A	6	7	8	8
5	1KS19CS080	Sahana.S	1	2	A	A	A	A	A	A	A	2
6	1KS19CS026	Devi Prasad N	1	2	A	3	4	A	A	A	A	4
7	1KS19CS075	Rv Yashvanth	1	A	A	A	A	A	A	A	A	1
8	1KS19CS116	Vrathika Billava	1	2	A	3	4	A	5	6	7	7
9	1KS19CS009	Amit K B	1	2	3	4	5	A	6	7	8	8
10	1KS19CS074	Puvan Kumar V	A	A	A	A	A	A	A	A	A	(A)
11	1KS19CS060	Neelamma Sali	1	2	A	A	A	A	A	A	A	2
12	1KS19CS077	Rakesh M J	A	A	A	A	A	A	A	A	A	(A)
13	1KS19CS112	Vishal Gupta	1	A	A	A	A	A	A	A	A	1
14	1KS19CS070	Prajwal Kulkarni	1	2	3	A	A	A	A	A	A	3
15	1KS19CS083	Sanjeev Mysore	A	A	A	1	2	A	A	A	A	2
16	1KS19CS091	Sindhu S	1	A	A	A	A	A	A	A	A	1
17	1KS19CS089	Shreya Kiran	1	A	A	2	A	A	A	A	A	2
18	1KS19CS058	NP Shashanka Rao	A	A	A	1	2	A	3	4	A	4
19	1KS19CS107	Thriveni U	1	2	A	3	A	A	5	6	A	6
20	1KS19CS087	Shivani. G. K	1	A	A	2	A	A	A	A	A	2
21	1KS19CS085	SATISH V	1	2	3	4	5	A	6	7	8	8
22	1KS19CS102	Tejas.n	1	A	A	A	A	A	A	A	A	1
23	1KS19CS081	Sai Shirisha S B	1	2	3	4	5	6	7	8	9	9
24	1KS19CS052	Manasa G L	1	2	A	3	4	A	A	A	A	4
25	1KS19CS104	Tejaswini Nayaka S	1	A	A	A	A	A	2	3	A	3
26	1KS19CS035	Harshitha J	1	A	A	2	3	A	4	A	A	4
27	1KS19CS017	Bhoomika AM	1	2	A	A	3	4	5	6	7	7
28	1KS19CS099	Syed Zain	1	2	A	3	4	5	A	A	A	5



29	1KS19CS069	Prajwal G	1	2	3	4	5	A	6	7	A	7
30	1KS19CS019	Bhumika M	1	2	3	4	5	6	A	A	A	6
31	1KS19CS071	Preethi K P	1	2	A	3	4	A	5	6	A	6
32	1KS19CS012	Anagha A Hebbar	1	2	A	A	A	A	A	A	A	2
33	1KS19CS094	Srusti S Gowda	A	A	A	A	A	A	A	A	A	(A)
34	1KS19CS049	Lisha C	A	A	A	A	A	A	A	A	A	(A)
35	1KS19CS034	Gulshan Kumar S	1	2	A	A	A	A	A	A	A	2
36	1ks19cs066	Pavithra s p	1	A	A	A	A	A	A	A	A	1
37	1KS19CS086	Shanvi B P	1	2	3	4	5	6	7	8	9	9
38	1KS19CS115	Akshay R	1	2	3	4	5	A	6	7	A	7
39	1KS19CS063	Nithya s n	1	2	3	4	5	A	6	7	8	8
40	1KS19CS073	Priyanka R	1	A	A	A	A	A	2	A	A	2
41	1KS19CS005	Ajay S Kalburgi	1	2	A	3	A	A	A	A	A	3
42	1ks19cs084	Sankalp Kesti	A	A	A	A	A	A	A	A	A	(A)
43	1KS19CS098	Swetha M kulkarni	1	2	A	A	A	A	A	A	A	2
44	1KS19CS030	G PRERITHA	1	2	A	3	4	A	5	6	7	7
45	1KS19CS068	Pothuru Sai Priyanka	1	A	A	2	3	A	A	A	A	3
46	1KS19CS033	Geethanjali BK Prasad	1	A	A	A	A	A	A	A	A	1
47	1KS19CS014	Anusha B	A	A	A	A	A	A	A	A	A	(A)
48	1KS19CS010	Amogha.HS	1	A	A	A	A	A	2	A	A	2
49	1KS19CS113	Yashwanth S R	1	2	3	4	A	A	A	4	A	4
50	1KS19CS056	N ASHOK	1	2	A	3	4	A	5	A	A	5
51	1KS19CS006	AKASH A S	A	A	A	A	A	A	A	A	A	(A)
52	1KS19CS079	Ranjitha DV	A	1	A	2	3	4	5	6	7	7
53	1KS19CS092	Smrithi Shekar	A	A	A	A	A	A	A	A	A	(A)
54	1ks19cs090	Shriharsha	A	A	A	A	A	A	A	A	A	(A)
55	1ks19cs016	Ashika HN	1	2	3	4	A	5	A	A	A	5
56	1KS19CS029	DINESH	1	A	A	2	3	A	A	A	A	3
57	1KS19CS028	Dheemanth G	1	2	A	A	A	A	A	A	A	2
58	1KS19CS065	Pavan L	1	2	A	3	4	A	A	4	A	4
59	1KS19CS039	K.R.VAGEESH	1	A	A	A	A	A	A	A	A	1
60	1KS19CS018	BHOOMIKA K	1	A	A	2	3	4	5	6	7	7
61	1KS19CS002	ABHISHEK B	1	A	A	2	3	A	4	A	A	4
62	1KS18CS068	Prajwal N	A	A	A	A	A	A	A	1	A	1
63	1KS19CS062	Nikhil Chowdary V R	1	2	A	3	4	A	A	4	A	4

73 1KS19CS110 VARSHA R

1 A A 2 3 4 A A A 4

74 1KS19CS050 MAHAKSHREE

1 A A A A A A A A 1



64	1KS19CS011	Amrutha	1	2	3	4	5	A	6	7	8	8
65	1KS19CS022	Chandan BV	1	A	A	A	A	A	A	A	A	1
66	1KS19CS048	Likith Gopalakrishna	1	2	A	3	4	A	5	6	A	6
67	1KS20CS403	Nithin S	1	2	3	A	A	A	A	A	A	4
68	1KS19CS021	Chaitanya Shivaraju	1	2	3	4	5	6	7	8	9	9
69	1KS19CS024	Deepa G	1	2	3	4	5	6	7	8	A	8
70	1KS19CS055	Mythreyi U	1	2	3	A	A	A	5	6	7	7
71	1KS19CS067	Pooja J	A	A	A	A	A	A	A	A	A	(A)
72	1KS19CS001	Aakriti	1	2	A	A	A	A	A	A	A	2
No. of students Absent			14	34	56	38	41	62	43	47	59	
No. of students Present			60	40	18	36	34	13	32	28	16	
Signature of the trainer/placement coordinator												

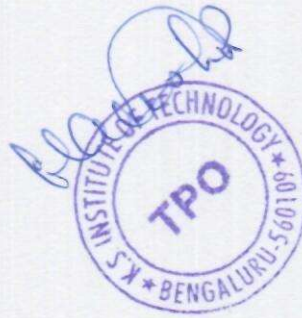





# K.S INSTITUTE OF TECHNOLOGY, BENGALURU

## DEPARTMENT OF TRAINING AND PLACEMENTS

### ATTENDANCE FOR NTT DATA COMPANY SPECIFIC TRAINING (BATCH 2) - NB SH 403

S. No	USN	NAME OF THE STUDENT	Dates									Total (09)
			26/09/2022			27/09/2022			28/09/2022			
			1	2	3	4	5	6	7	8	9	
1	1KS19CS057	N Bhavya	1	A	A	A	A	A	A	A	A	1
2	1KS19CS004	Adith Karthik Raju	A	A	A	A	A	A	A	A	A	(A)
3	1KS19CS042	KavyaShree S L	A	A	A	1	2	3	A	A	5	5
4	1KS19EC074	Sai Priya TS	1	A	A	A	A	A	A	A	A	1
5	1KS19EC073	Sahana.S	1	2	A	3	4	5	6	7	8	8
6	1KS19EC093	Sushmitha S	1	2	A	3	A	5	6	7	A	7
7	1KS19EC078	Shamitha bijoor	1	2	A	3	4	5	6	7	A	7
8	1KS19EC087	Srinivas S	1	2	3	4	5	6	7	8	A	8
9	1KS19EC086	Sinchana mn	1	2	A	3	4	5	6	7	A	7
10	1KS19EC050	Monisha B K	1	2	3	4	5	6	7	8	A	8
11	1KS19EC018	Chennreddy Rajasekhar	1	2	3	4	5	6	7	A	A	7
12	1KS19EC104	Vikas S	A	A	A	1	2	A	A	A	A	2
13	1KS19EC069	Rohan K R	1	2	A	3	A	A	A	A	A	3
14	1KS19EC022	Davino Joseph	1	2	A	3	4	5	6	A	A	6
15	1KS19EC042	LAKSHMAN KUMARA.B	1	2	3	4	5	6	7	A	A	7
16	1KS19EC001	Abhilash A S	1	2	3	4	5	6	7	A	A	7
17	1KS19EC035	Jagruti pai	1	A	A	2	3	4	5	6	7	7
18	1KS19EC096	T N L RUTHVIK	1	2	3	4	5	6	7	8	A	8
19	1KS19EC103	Vignesh muthaiah R	A	A	A	A	A	A	A	A	A	(A)
20	1KS19EC011	Archana Yadav M	1	2	3	4	5	6	A	7	A	7
21	1KS19EC102	Vandana S	1	2	3	A	A	A	4	5	6	6
22	1KS19EC007	Amruta	1	2	3	4	5	6	7	8	A	8
23	1KS19EC041	Kruthik s	1	2	A	3	4	A	5	6	7	7
24	1KS19EC051	N.ANILA	1	2	3	4	5	6	7	8	A	8
25	1KS19EC004	Aishwarya M G	1	2	3	4	5	6	7	8	A	8
26	1KS19EC020	D Nayan	1	2	A	3	4	A	5	6	A	6
27	1KS19EC068	RANGASWAMY U	A	A	A	A	A	A	1	2	3	3
28	1KS19EC107	Vishnuraata Yadunandan	1	2	A	3	4	5	6	7	A	7
29	1KS19EC063	PREETHAM G H	A	A	A	1	2	3	4	A	A	4



30	1KS19EC084	Shreyas V Bharadwaj	A	1	2	3	4	A	5	6	A	6
31	1KS19EC043	Likitha H	1	2	A	3	4	A	A	5	A	5
32	1KS19EC055	Pavan Kumar G R	1	2	3	4	5	6	7	8	A	8
33	1KS19EC070	S K Bharatesh	1	2	3	4	5	6	7	8	A	8
34	1KS19EC028	Gayathri R Warriier	1	2	3	4	5	6	7	8	9	9
35	1KS19EC017	Chandana L	1	2	3	4	5	6	7	8	A	8
36	1KS19EC014	Bhavana S	1	2	A	3	4	A	5	6	A	6
37	1KS19EC044	M Lokeshwaria	A	1	2	3	4	5	6	7	8	8
38	1KS19EC025	Disha Shivani	1	2	3	A	A	A	A	A	A	3
39	1ks19ec049	Monika V Arya	A	A	A	1	2	3	4	5	6	6
40	1KS19EC009	Anitha.S	1	2	3	4	5	6	7	8	9	9
41	1KS19EC094	Swagath Aithal PG	1	2	3	A	4	A	A	5	6	6
42	1KS19EC010	Anjali Y J	1	2	3	4	5	A	6	7	A	7
43	1KS19EC040	Krupa A	A	A	A	1	2	A	3	4	5	5
44	1KS19EC079	SHASHANK KASHYAP HR	1	2	A	3	4	5	6	7	8	8
45	1KS19EC033	Hemanth R Patil	1	2	3	4	5	6	7	A	A	7
46	1KS19EC006	Akshitha	A	1	2	3	4	5	6	7	8	8
47	1KS19EC106	Vishal Sanjay Raju	1	2	A	3	4	A	5	6	A	6
48	1KS19EC021	Danesh Raju v	1	2	3	4	5	6	7	A	8	8
49	1KS19EC008	Amulya R	1	2	3	4	5	A	6	7	8	8
50	1KS19EC046	Meghana H P	1	2	3	4	5	6	7	8	A	8
51	1KS19EC064	Priyanka K	1	2	3	4	5	6	7	8	A	8
52	1KS19EC039	Kashyap P	1	2	A	A	A	A	3	4	A	4
53	1KS19EC061	Prashanth SK	A	1	2	3	4	5	6	7	A	7
54	1KS19EC030	Gowri S N	1	2	3	4	5	6	A	7	8	8
55	1KS19EC053	Nisargak	A	A	A	1	2	3	4	5	6	6
56	1KS19EC037	Manogna K M	A	1	2	3	4	5	6	7	8	8
57	1KS19EC045	Manu N Kandra	A	1	2	3	4	5	6	7	8	8
58	1KS19EC024	DHEEMANTH KN	1	2	3	4	5	6	7	A	8	8
59	1KS19EC032	B.Y.Harshitha	1	2	3	A	A	A	4	5	A	5
60	1KS19EC003	Aishwarya Basavaraja Kembavi	1	2	3	4	5	6	7	8	9	9
61	1KS19EC092	SUMUKHA VASISHTA M R	1	2	A	3	4	5	6	7	8	8
62	1KS19EC056	Pokuri Mounika	1	A	A	2	3	A	A	A	A	3
63	1KS19EC101	Vandana.G	1	2	3	4	5	6	7	8	9	9
64	1KS19EC005	Akshay kumar d	1	2	3	4	5	6	7	8	9	9
65	1KS19EC016	Chandan Raj Y	1	2	3	4	5	A	6	7	8	8



66	1KS19EC085	Shubham Kumar Singh A	1	2	A	3	4	5	6	7	8	8
67	1KS19EC076	Santosh Hegde	1	2	3	4	5	6	7	8	9	9
68	1ks19ec098	Theerthana S R	1	2	A	3	4	5	6	7	A	7
69	1KS19EC082	Shreyas B Aradhya	A	A	A	A	A	A	A	A	A	(A)
70	1KS19EC015	Chaitra p	1	2	A	3	4	A	5	6	7	7
71	1KS19EC027	Gayathri P K	1	A	A	A	A	A	A	A	A	1
No. of students Absent			16	16	34	12	12	26	15	18	44	
No. of students Present			55	56	38	60	60	46	57	54	28	
Signature of the trainer/placement coordinator			P	P	P	P	P	P	P	P	P	P





# Departments of Training and Placements

## *NTT DATA Company Specific Training Program\_2022-2023*

Date: 26<sup>th</sup> – 28<sup>th</sup> September 2022

Semester: 7<sup>th</sup> Semester (CSE & ECE)

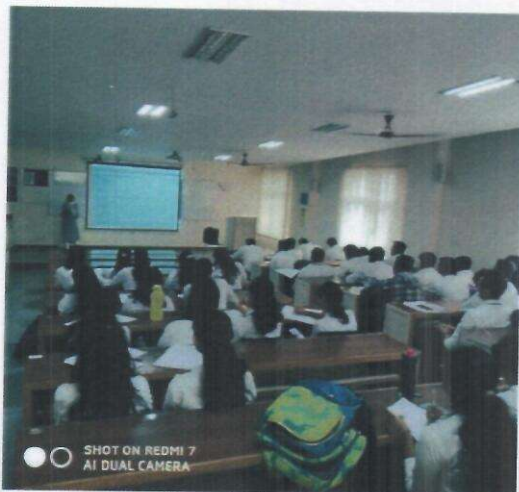

Batch 1: CSE – Session 2 (Day 3)

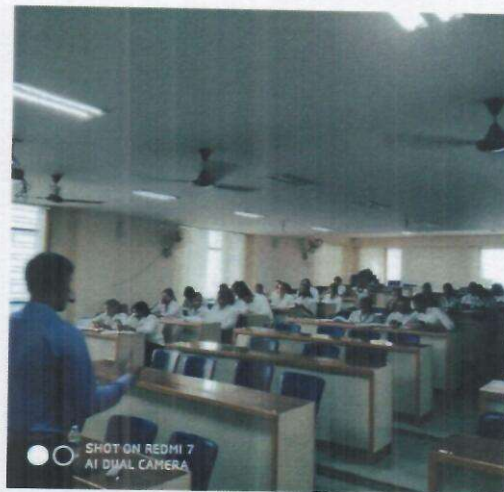

Batch 2: ECE – Session 3 (Day 3)

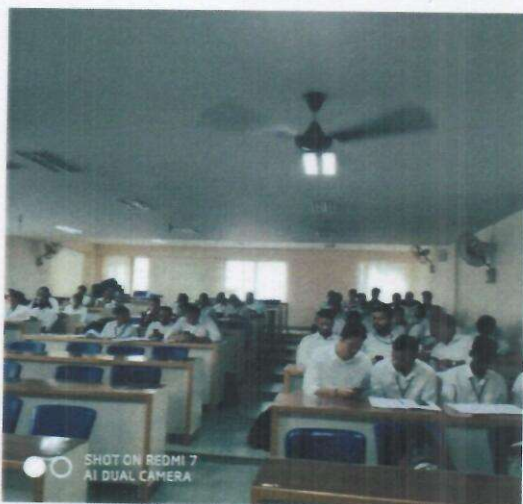

Batch 1: CSE – Session 3 (Day 2)

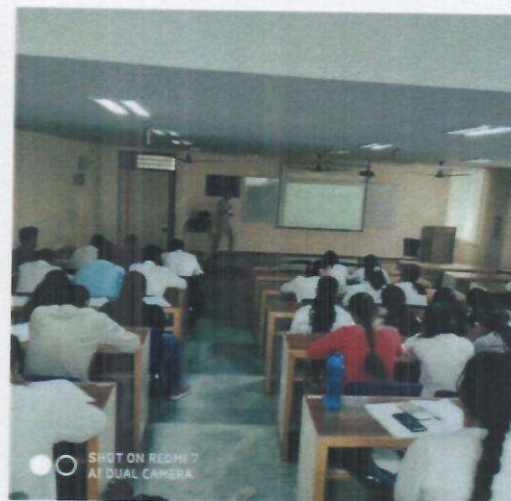

Batch 2: ECE – Session 1 (Day 1)



**K.S. INSTITUTE OF TECHNOLOGY**

**DEPARTMENT OF MECHANICAL ENGINEERING  
SKILL DEVELOPMENT REPORT - 2022**

As part of skill development program, 3<sup>rd</sup> semester students were given training in solid modeling, finite element analysis and Ansys in a 5 day program. The program schedule is as follows.

Internship program for 3<sup>rd</sup> Semester

5 days program for 3<sup>rd</sup> semester mechanical students(17/10/22 – 21/10/22) :

Date	Program Description	Time	Staff
17/10/2022	Introduction to Autocad and practice	9 am – 12.30 pm	Harish U
	Practice on block, layer commands	1.15 pm – 4 pm	Harish U
18/10/2022	Practice on Autocad drafting exercises	9 am – 12.30 pm	Harish U
	Tolerance representation	1.15 pm – 4 pm	Harish U
19/10/2022	Introduction to Matlab and Matlab programming	9 am – 12.30 pm	M. Nagabhushana
	Programming aspects of Matlab	1.15 pm – 4 pm	M. Nagabhushana
20/10/2022	Matlab programming	9 am – 12.30 pm	M. Nagabhushana
	Function writing	1.15 pm – 4 pm	M. Nagabhushana
21/10/2022	Introduction to Ansys workbench and practice on engineering problems	9 am – 12.30 pm	M. Nagabhushana
	Report generation using workbench	1.15 pm – 4 pm	M. Nagabhushana

*[Signature]* 11/10/22  
Head of the Department  
Dept. of Mechanical Engg  
K.S. Institute of Technology  
Bengaluru - 560 109.

*[Signature]* 11/10/22

Schedule for Training

Before starting with the training, need of CAD and CAE technologies were discussed and the discussed matter is as follows.



### **About Training:**

Technology has advanced at an ever increasing, almost exponential rate. In fact, technology development moves faster than the consumers understanding of the resulting product enhancements. When an activity of the product development cycle is carried out in a virtual or soft environment, the primary benefit is the time saving and hence cost saving

Computer Aided Engineering is a technology concerned with the use of computer systems to analyze CAD geometry, allowing the designer to simulate and study how the product will behave so that design can be refined and optimized.

### **History of FEA:**

Finite Element Analysis (FEA) was first developed in 1943 by R. Courant, who utilized the Ritz method of numerical analysis and minimization of variational calculus to obtain approximate solutions to vibration systems. Shortly thereafter, a paper published in 1956 by Turner, Clough, Martin, & Top established a broader definition of numerical analysis. This paper centered on the "stiffness and deflection of complex structures".

By the early 70's, FEA was limited to expensive mainframe computers generally owned by the aeronautics, automotive, defense, and nuclear industries, and the scope of analyses were considerably limited. Such people as Zeinkiewich & Cheung further enhanced finite Element technology during the 70's, when they applied the technology to general problems described by Laplace & Poisson's equations. Mathematicians were developing better solution algorithms, the Galerkin, Ritz & Rayleigh-Ritz methods emerged as the optimum solutions for certain categories of general type problems. Later, considerable research was carried out into the modeling & solution of non-linear problems, Hinton & Crisfield being major contributors. While considerable strides were made in the development of the finite element method, other areas did not remain static. Very powerful mesh generation algorithms have been developed. Commercial generators have the capability of meshing all but the most difficult geometry. Superior CAE concepts have also emerged; it is not unusual to have a single CAD model for producing engineering drawings, carrying out kinematics & assembly analysis, as well as being used



for finite element modeling. Due to the rapid decline in the cost of computers and the phenomenal increase in computing power, present day desktop computers are capable of producing accurate results for all kinds of parameters (standard PC's are over 10 times more powerful than the best supercomputers of the early 90's)

The finite element method now has its roots in many disciplines, the end result is a technology that is so advanced that it is almost indistinguishable from magic. The vast catalog of capability that comprises FEA will no doubt grow considerably larger in the future. CAE is here to stay, but in order to harness its true power, the user must be familiar with many concepts, including the mechanics of the problem being modeled. All analyses require time, experience & most importantly, careful planning.

The finite element method is being used in virtually every engineering discipline. Aerospace, automotive, biomedical, geotechnical, electrical, hydraulic, and nuclear engineering applications have become standard objects for finite element analysis. In addition, it is not only used for analyzing classical static structural problems, but also for such diverse areas as mass transport, heat transfer, dynamics, stability, and radiation problems. Like any other approximate numerical method, the solution produced by finite element analysis contains a certain amount of error. The magnitude of the error is highly dependent on the type, size, and fineness of the model used for the analysis. That's why not all finite element models are created equal. Indeed, the educational and industrial experiences of the analyst as well as the sophistication of the software are the most critical factors in obtaining reliable results.

### **Finite Element Analysis:**

Is the simulation of a physical system (geometry and loading environment) by a mathematical approximation of the real system. Using simple, interrelated building blocks called elements; a real system with infinite unknowns is approximated with a finite number of unknowns. A FEA Model is the mathematical idealization of the real system.



## **A Typical Analysis Procedure:**

In the real world, no analysis is typical, as there are usually facets that cause it to differ from others. There is however a main procedure that most FE investigations take. This procedure is detailed below:

### **Planning the Analysis:**

This is arguably the most important part of any analysis, as it helps ensure the success of the simulation. Oddly enough, it is usually the one analysts leave out. The purpose of an FE analysis is to model the behavior of a structure under a system of loads. In order to do so, all influencing factors must be considered & determined whether their effects are considerable or negligible on the final result. The degree of accuracy to which any system can be modeled is very much dependant on the level of planning that has been carried out.

### **Pre-Processor**

The preprocessor stage in general FE packages involves the following:

1. Specifying the title that is the name of the problem. This is optional but very useful,
2. Setting the type of analysis to be used, e.g. structural, fluid, thermal or electromagnetic, etc. (sometimes this can only be done by selecting a particular element type). Especially if a number of design iterations are to be completed on the same base model.
3. Creating the model. The model is drawn in 1D, 2D or 3D space in the appropriate units (M, mm, in, etc..). The model may be created in the pre-processor, or it can be imported from another CAD drafting package via a neutral file format (IGES, STEP, ACIS, Parasolid, DXF, etc.). If a model is drawn in mm for example and the material properties are defined in SI units, then the results will be out of scale by factors of  $10^6$ . The same units should be applied in all directions, otherwise results will be difficult to interpret, or in extreme cases the results will not show up mistakes made during the loading and restraining of the model.



4. Defining the element type, this may be 1D, 2D or 3D, and specific to the analysis type being carried out (you need thermal elements to do thermal analyses).

5. Applying a Mesh. Mesh generation is the process of dividing the analysis continuum into a number of discrete parts or finite elements. The finer the mesh, the better the result, but the longer the analysis time. Therefore, a compromise between accuracy & solution speed is usually made.

6. Assigning properties. Material properties (Young's modulus, Poisson's ratio, the density, & if applicable, coefficients of expansion, friction, thermal conductivity, damping effect, specific heat etc.) will have to be defined. In addition element properties may need to be set. If 2D elements are being used, the thickness property is required. 1D beam elements require area,  $I_{xx}$ ,  $I_{yy}$ ,  $I_{xy}$ ,  $J$ , & a direction cosine property, which defines the direction of the beam axis in 3D space. Shell elements, which are 2½D in nature (2D elements in 3D space), require orientation & neutral surface offset parameters to be defined. Special elements (mass, contact, spring, gap, coupling, damper etc.) require properties (specific to the element type) to be defined for their use.

7. Apply Loads. Some type of load is usually applied to the analysis model. The loading may be in the form of a point load, a pressure or a displacement in a stress (displacement) analysis, a temperature or a heat flux in a thermal analysis & a fluid pressure or velocity in a fluid analysis. The loads may be applied to a point, an edge, a surface or a even a complete body. The loads should be in the same units as the model geometry & material properties specified. In the cases of modal (vibration) & buckling analyses, a load does not have to be specified for the analysis to run.

8. Applying Boundary Conditions. If you apply a load to the model, then in order to stop it accelerating infinitely through the computer's virtual ether (mathematically known as a zero pivot), at least one constraint or boundary condition must be applied. Structural boundary conditions are usually in the form of zero displacements, thermal BCs are usually specified temperatures, fluid BCs are usually specified pressures. A boundary condition may be specified to act in all directions (x, y, z), or in certain directions only. They can be placed on nodes, key points, areas or on lines. BC's on lines can be in the form of symmetric or anti-symmetric type boundary conditions, one allowing in plane rotations and out of plane translations, the other allowing in plane translations and out of



plane rotations for a given line. The applications of correct boundary conditions are a critical to the accurate solution of the design problem. At least one BC has to be applied to every model, even modal & buckling analyses with no loads applied.

### **Solution**

Thankfully, this part is fully automatic. The FE solver can be logically divided into three main parts, the pre-solver, the mathematical-engine & the post-solver. The pre-solver reads in the model created by the pre-processor and formulates the mathematical representation of the model. All parameters defined in the pre-processing stage are used to do this, so if you left something out, chances are the pre-solver will complain & cancel the call to the mathematical-engine. If the model is correct the solver proceeds to form the element-stiffness matrix for the problem & calls the mathematical-engine, which calculates the result (displacement, temperatures, pressures, etc.). The results are returned to the solver & the post-solver is used to calculate strains, stresses, heat fluxes, velocities, etc.) for each node within the component or continuum. All these results are sent to a results file, which may be read by the post-processor.

### **Post-Processor**

Here the results of the analysis are read & interpreted. They can be presented in the form of a table, a contour plot, deformed shape of the component or the mode shapes and natural frequencies if frequency analysis is involved. Other results are available for fluids, thermal and electrical analysis types. Most post-processors provide an animation service, which produces an animation & brings your model to life.

Contour plots are usually the most effective way of viewing results for structural type problems. Slices can be made through 3D models to facilitate the viewing of internal stress patterns.

All post-processors now include the calculation of stress & strains in any of the x, y or z directions, or indeed in a direction at an angle to the coordinate axes. The principal stresses and strains may also be plotted, or if required the yield stresses and strains according to the main theories of failure (Von mises, St. Venant, Tresca etc.). Other



information such as the strain energy, plastic strain and creep strain may be obtained for certain types of analyses.

A Final Word The finite element method is extremely powerful. However, with comforting contour plots, one can be easily fooled into thinking that a superior result has been achieved. The quality of the result is totally dependent on the quality of the analysis model & how accurately it represents the physical problem being investigated. Careful planning is the key to a successful analysis. Sometimes an analysis is not required, as some problems have analytical or empirical solutions; others may be determined using spreadsheets.

General finite element process is illustrated as below:

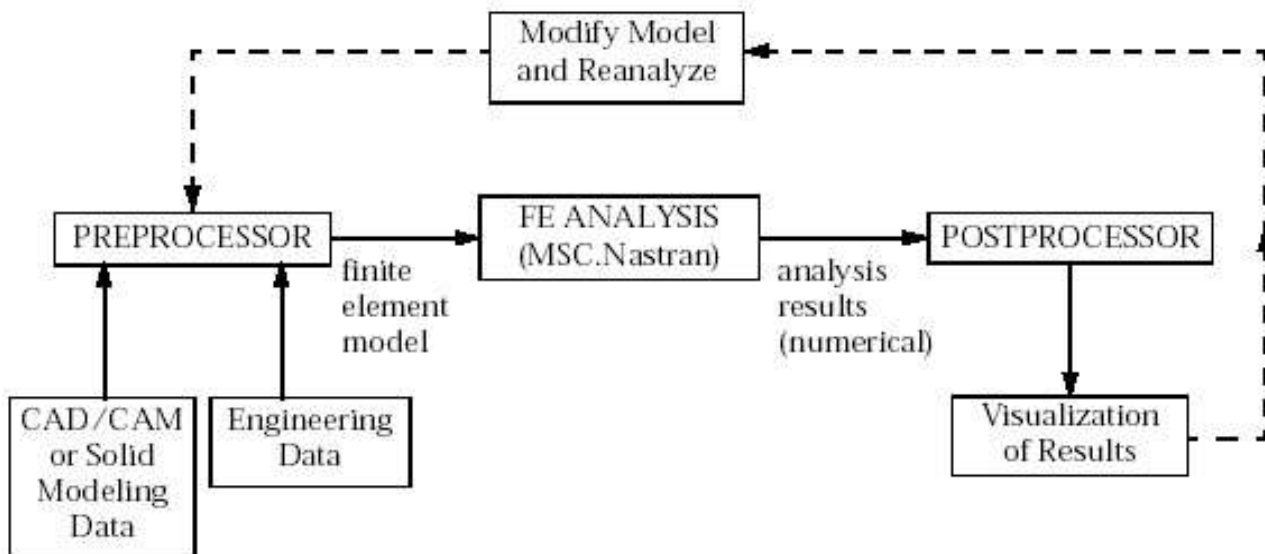

### IMPORTING AND EXPORTING DATA

The cad models in step and sat file format creation is important for importing into analysis softwares for further analysis.

As part of training , the following problems were given training to the students.



## **CASE STUDY 1: RECTANGULAR PLATE WITH ELLIPTICAL HOLE**

### **Objectives:**

- Manually create the geometry using the given dimensions then apply finite elements.
- Manually define material and element properties.
- Apply symmetric boundary constraints.
- Apply edge load to model.
- Run the analysis in ansys

### **MODEL DISCRIPTION:**

Below is a schematic of a plate with a elliptical hole at the center. The dimensions and loads are indicated. The finite element model will be simplified by creating the 1/4 tension model with two simple surfaces as shown in Fig. The plate is 10mm thick; therefore it will be modeled with shell elements. The resulting finite element model will have x- and y-symmetry constraints. The uniform load of 30 kg will be applied to the right edge.

All dimensions are in mm

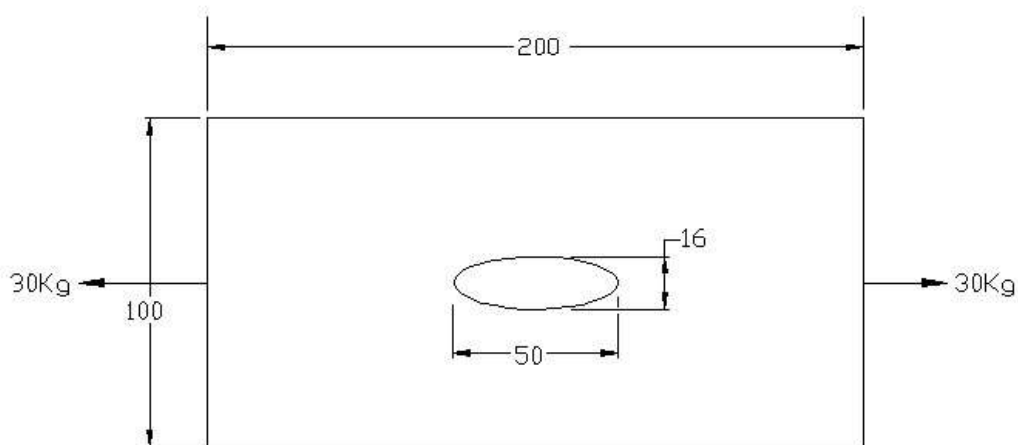

Fig: Geometry details



## Skill Development Report

---

Material=Aluminium

Thickness:  $t = 10\text{mm}$

Applied Load:  $F = 30\text{mm}$

Youngs

modulus= $7100\text{kg/mm}^2$

Poisson Ratio = 0.33

Thickness= $10.0\text{mm}$

$$\begin{aligned}\sigma_{\max} &= K \sigma_{\text{nom}} \\ &= 1.64 * 0.047 = 0.077\text{kg/mm}\end{aligned}$$

$$\begin{aligned}\text{Nominal stress } (\sigma_{\text{nom}}) &= F/A \\ &= 30/628.4 = 0.047 \text{ kg/mm}^2\end{aligned}$$

Stress Concentration Factor (K) =  $1 + 2(a/b)$

For Elliptical  $a = 25\text{mm}, b = 8\text{mm}$

$$K = 1 + 2(8/25)$$

$$K = 1.64$$

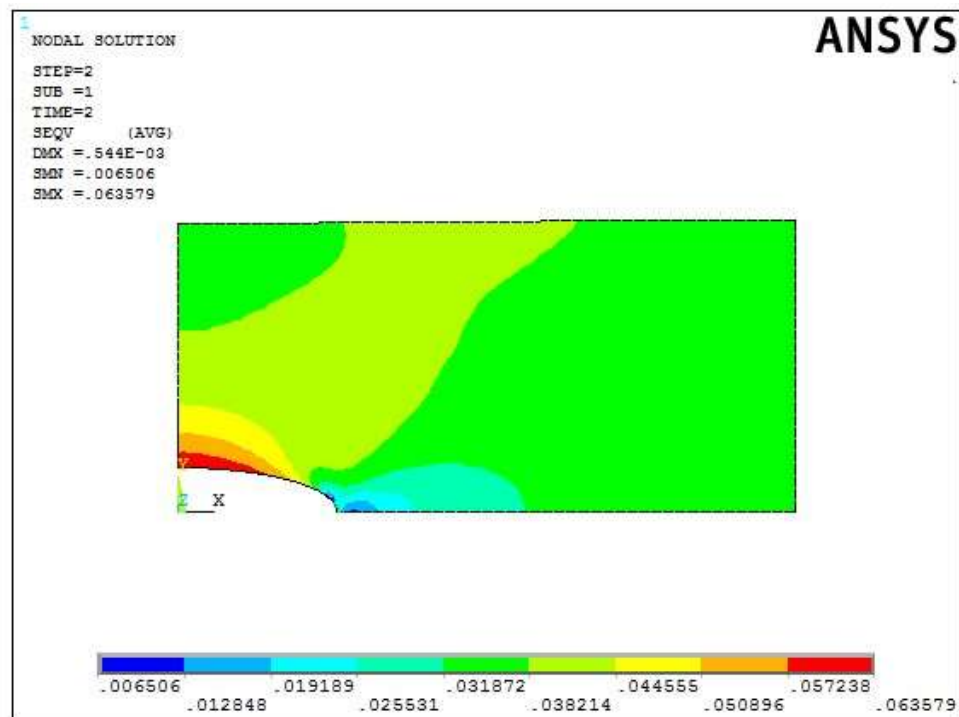

Fig: Vonmises stress plot

From ansys :



$$K=0.0635/0.047=1.35$$

**Biaxial Loading:**

$$\text{Maximum stress } (\sigma_{\max}) = 2.66 \text{ kg/mm}^2$$

$$\text{Nominal stress } (\sigma_{\text{nom}}) = 1.381 \text{ kg/mm}^2$$

$$\begin{aligned} \text{Stress Concentration Factor (K)} &= \sigma_{\max} / \sigma_{\text{nom}} \\ &= 2.66 / 1.381 \end{aligned}$$

$$K=1.92$$

**CASE STUDY 2: FRAME OF A PUNCH PRESS.**

**Objective:**

To find the stresses at the inner and outer surface at section of a punch press with load  $W=5000\text{N}$

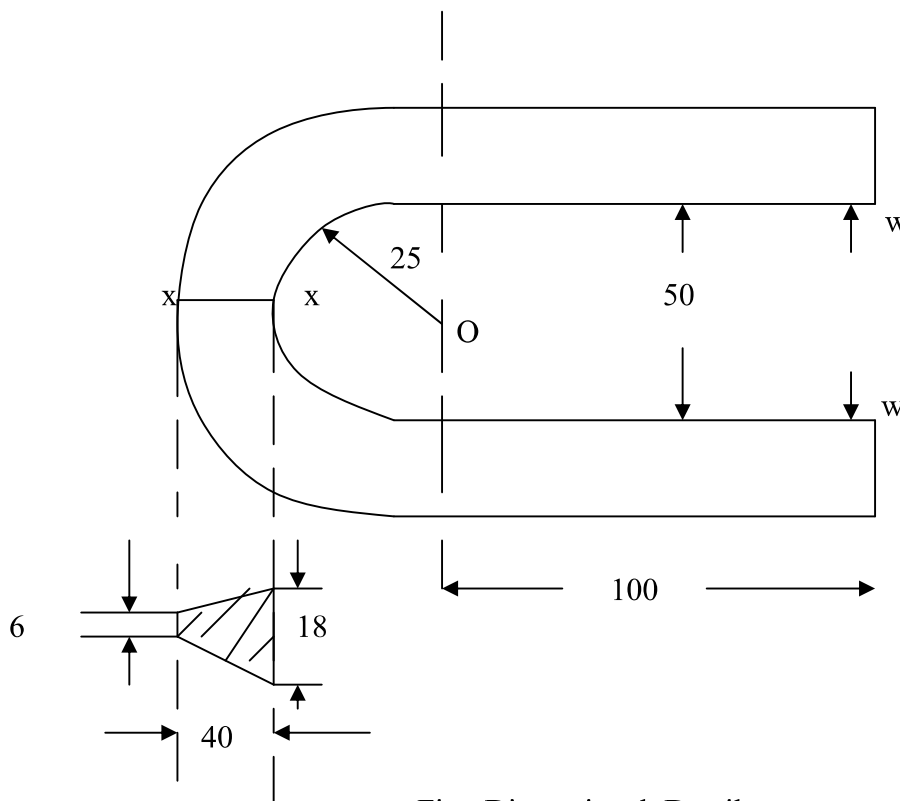

Fig: Dimensional Details

Given:  $W=5000\text{N}$ ,  $b_i = 18\text{mm}$ ,  $b_o = 6\text{mm}$ ,  $h=40\text{mm}$ ,  $R_i = 25\text{mm}$ ,  $R_o = 25+40=65\text{mm}$ .



Wkt area of section X-X,

$$A = \frac{1}{2}(18+6) \times 40 = 480\text{mm}^2$$

Radius of curvature of the neutral axis ,

$$R_n = \frac{(b_i + b_o/2)h}{(b_i R_o - b_o R_i / h) \log(R_o / R_i)(b_i - b_o)}$$

$$R_n = \frac{(18+6/2)*40}{(18*65-6*25/40) \log(65/ 25)( 18 -6)}$$

$$R_n = 38.83\text{mm}.$$

Radius of curvature of the centroidal axis,

$$R = R_i + \frac{h(b_i + 2b_o)}{3(b_i + b_o)} = 25 + \frac{40(18+2*6)}{3(18+6)}$$

$$R = 41.67\text{mm}.$$

Distance between the centroidal and neutral axis,

$$E = R - R_n = 41.67 - 38.83 = 2.84\text{mm}$$

And the distance between the load and centroidal axis,

$$X = 100 + R = 100 + 41.67 = 141.67\text{mm}.$$

Therefore bending moment about the centroidal axis ,

$$M = W.x = 5000 * 141.67 = 708350 \text{ N-mm}.$$



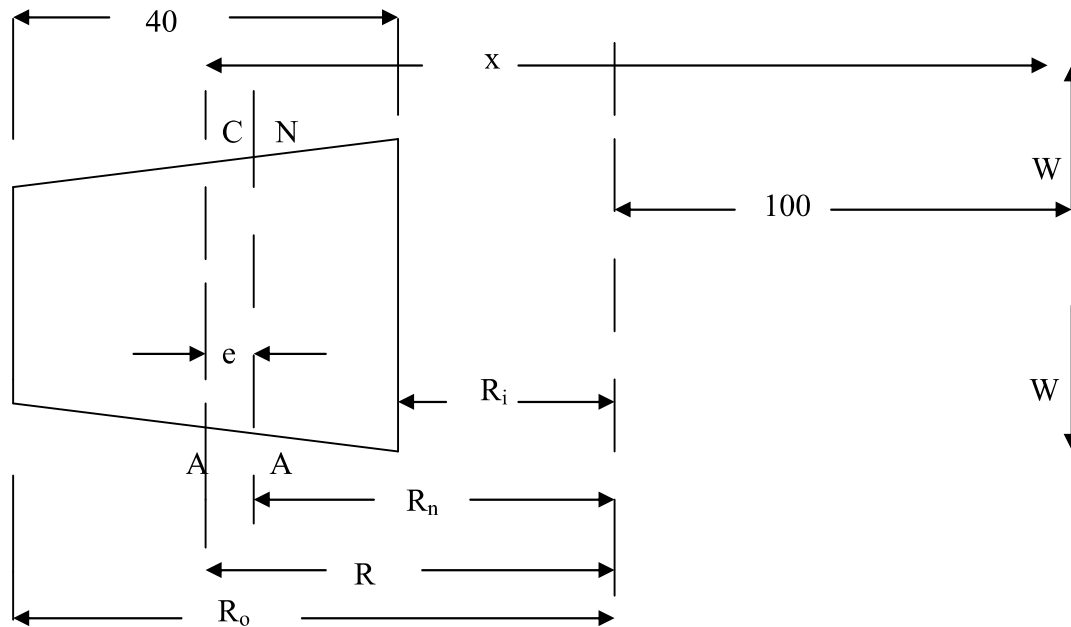

Fig: Sectional details

The direct tensile stress at section X-X.

$$\sigma_t = W/A = 5000/480 = 10.42 \text{ N/mm}^2$$

Distance from the neutral axis to the inner surface,

$$y_i = R_n - R_i = 38.83 - 25 = 13.83 \text{ mm}$$

Distance from the neutral axis to the outer surface,

$$y_o = R_o - R_n = 65 - 38.83 = 26.17 \text{ mm.}$$

Wkt maximum bending stress at the inner surface,

$$\begin{aligned} \sigma_{bi} &= \frac{M \cdot y_i}{A \cdot e \cdot R_i} = \frac{708350 \cdot 13.83}{480 \cdot 2.84 \cdot 25} = 287.4 \text{ N/mm}^2 \\ &= 287.4 \text{ Mpa (tensile)} \end{aligned}$$

Maximum bending stress at the outer surface,

$$\sigma_{bo} = \frac{M \cdot y_o}{A \cdot e \cdot R_o} = \frac{708350 \cdot 26.17}{480 \cdot 2.84 \cdot 65} = 209.2 \text{ N/mm}^2$$



$$= 209.2 \text{ Mpa (compressive)}$$

**Therefore resultant stress on the inner surface**

$$= \sigma_t + \sigma_{bi} = 10.42 + 287.4 = 297.82 \text{ Mpa (tensile)}$$

**Resultant stress on the outer surface,**

$$= \sigma_t - \sigma_{bo} = 10.42 - 209.2 = -198.78 \text{ Mpa (compressive)}$$

FROM FEA METHOD:

FE Model of a punch press.

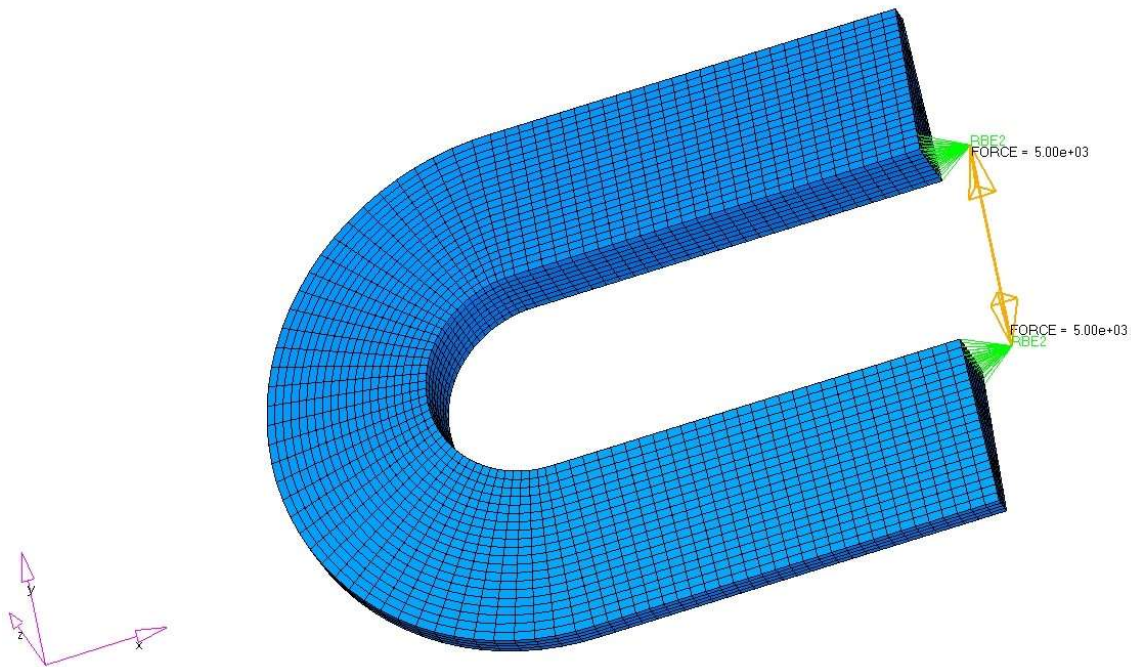
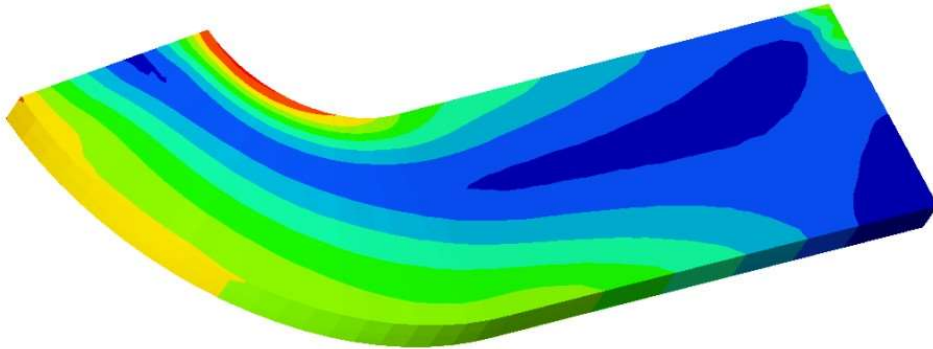

Fig: Mesh model

Due to half symmetry, half model with symmetrical boundary conditions were analysed.





Results from FEA

**Stress – Von Mises**

**Resultant stress on the inner surface,**

**= 286.4 Mpa (tensile).**

**Resultant stress on the outer surface,**

**= 191.0 Mpa (compressive)**



**CASE 3 : L-Frame Stress analysis subjected to 1000N Cabin load**

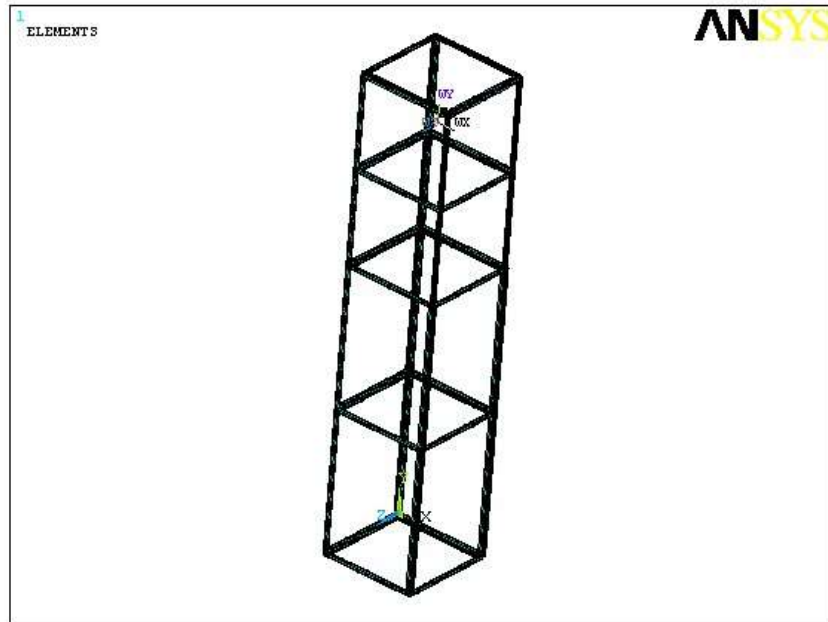

**Fig: L Frame Element Plot**

The above picture shows element representation of the problem.

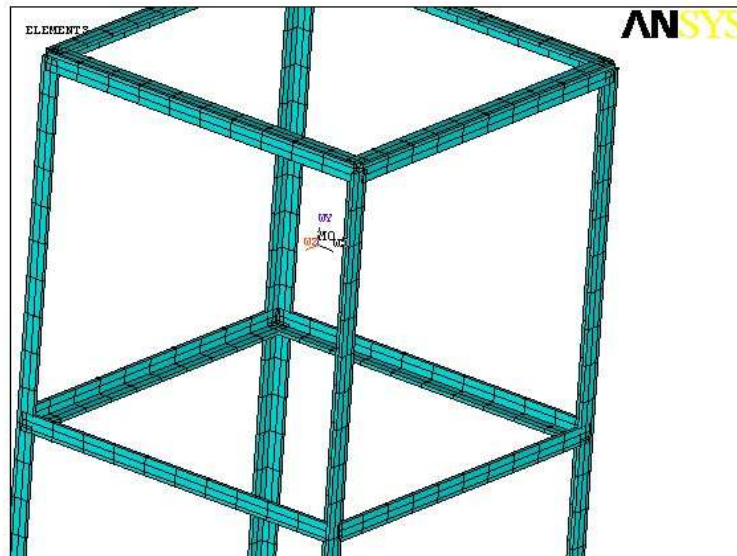

**Fig : Zoomed view of Frame**

The above picture shows zoomed view of the problem. L sections are used for creating the model



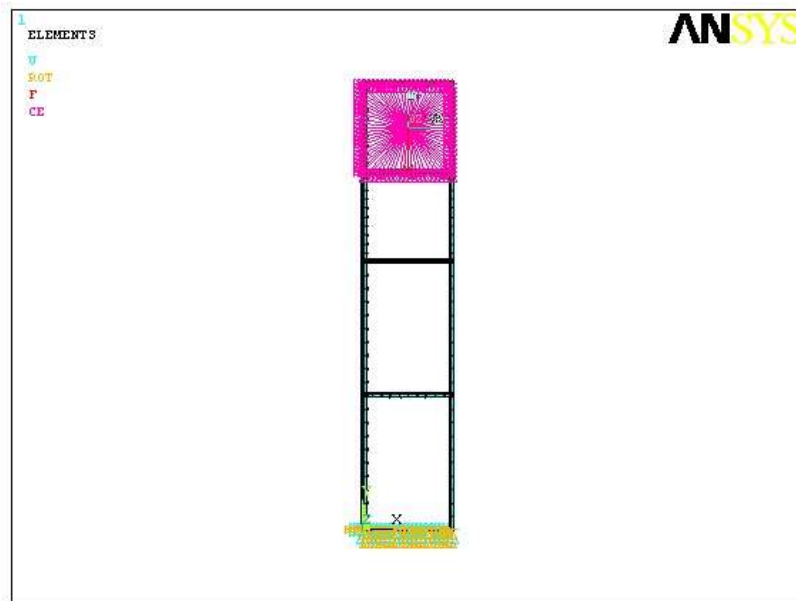

Fig : Boundary Conditions of the problem

The above picture shows applied boundary conditions of the problem. RBE elements are used to apply the cabin weight load of 1000N. The RBE linking is shown with red color.

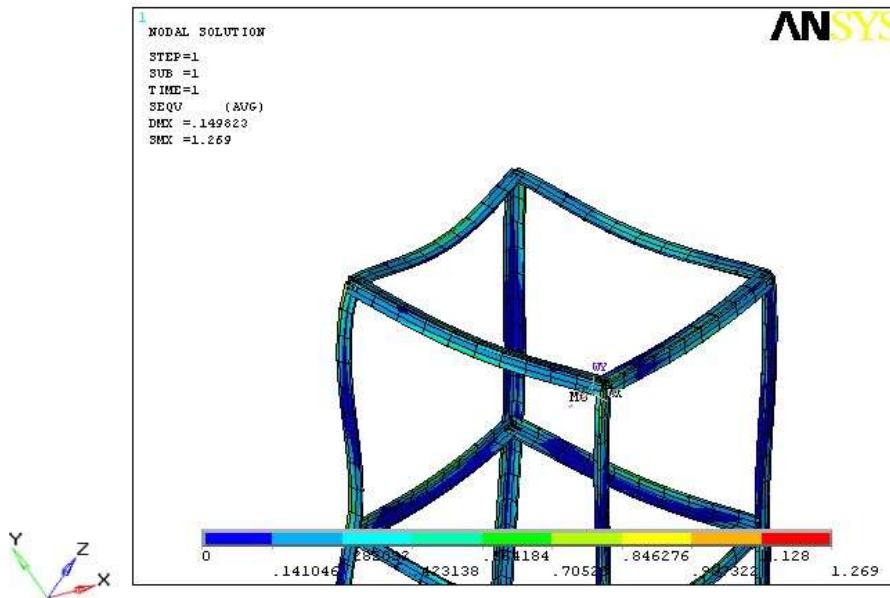

Fig : Vonmises Stress in the problem

The above picture shows vonmises stress in the problem. Maximum vonmises is around 1.269 Mpa due to the loading. The variation of stresses are represented in the status bar.



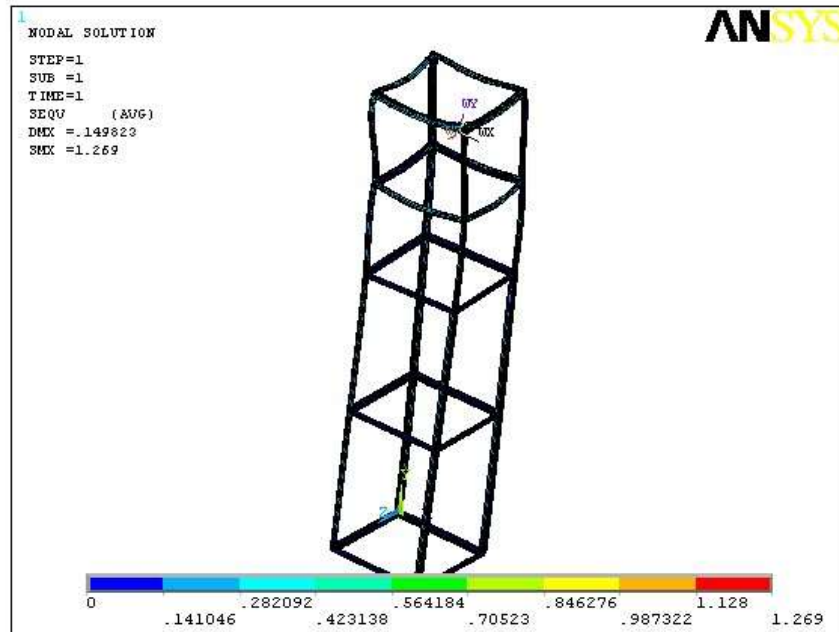

Fig : Vonmises Stress in the problem

The vonmises stress distribution is shown in the picture. Maximum vonmises stress is around 1.269 Mpa for the given loads.

### Autocad Training :

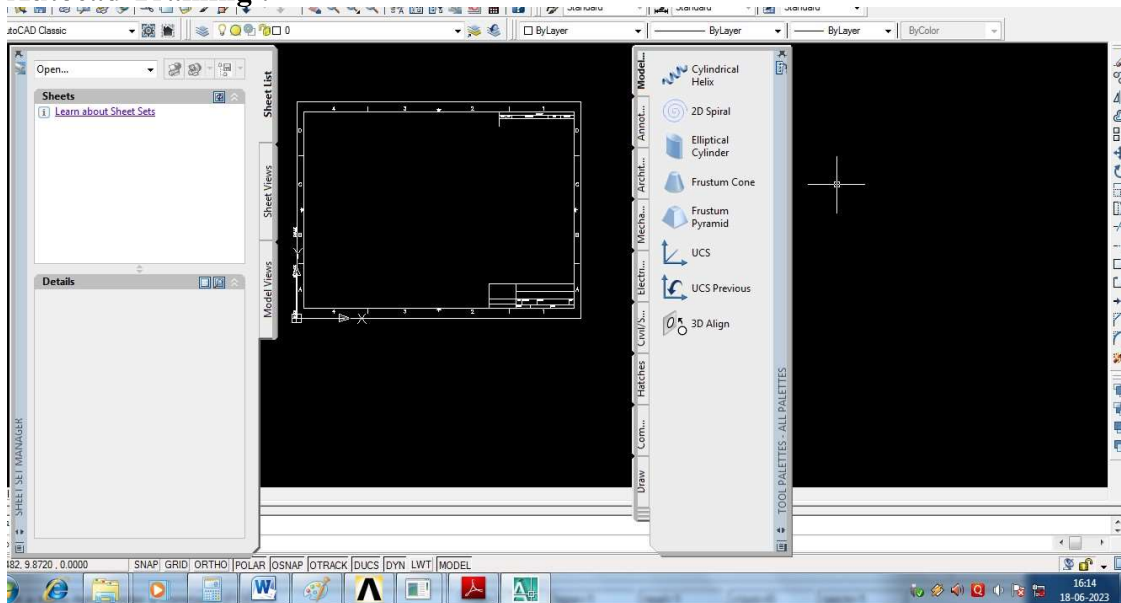
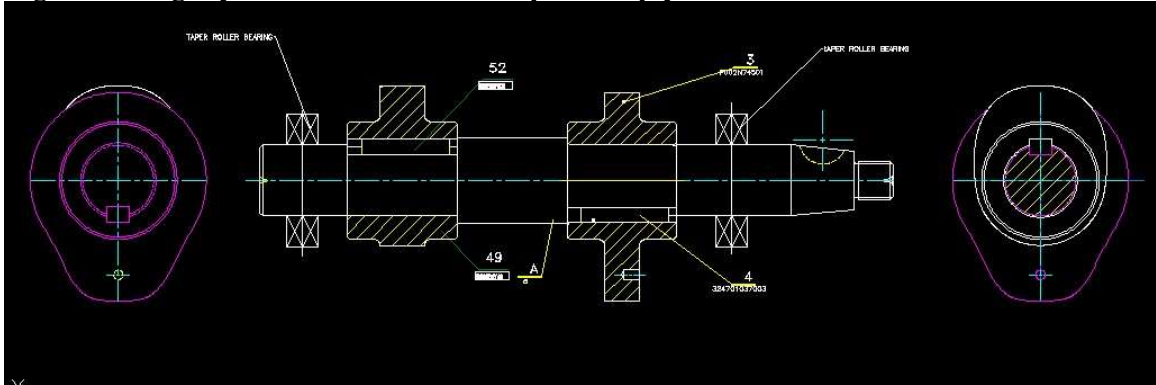

Fig: New sheet representation





**Fig: Drawing a profile section for axisymmetry problem**



**Fig: Dimensional representation of cam shaft assembly**







Fig: Students undergoing training

### Conclusion

The students undergone training in autocad and ansys and applied various ansys modeling techniques for geometrical built up and analysis along with possible theoretical validation. In autocad they practiced basic autocad commands and generated few drawings in two dimensional space.

*K. S. Kumar*

PRINCIPAL  
K.S INSTITUTE OF TECHNOLOGY  
BENGALURU - 560 109